

GARMIN®

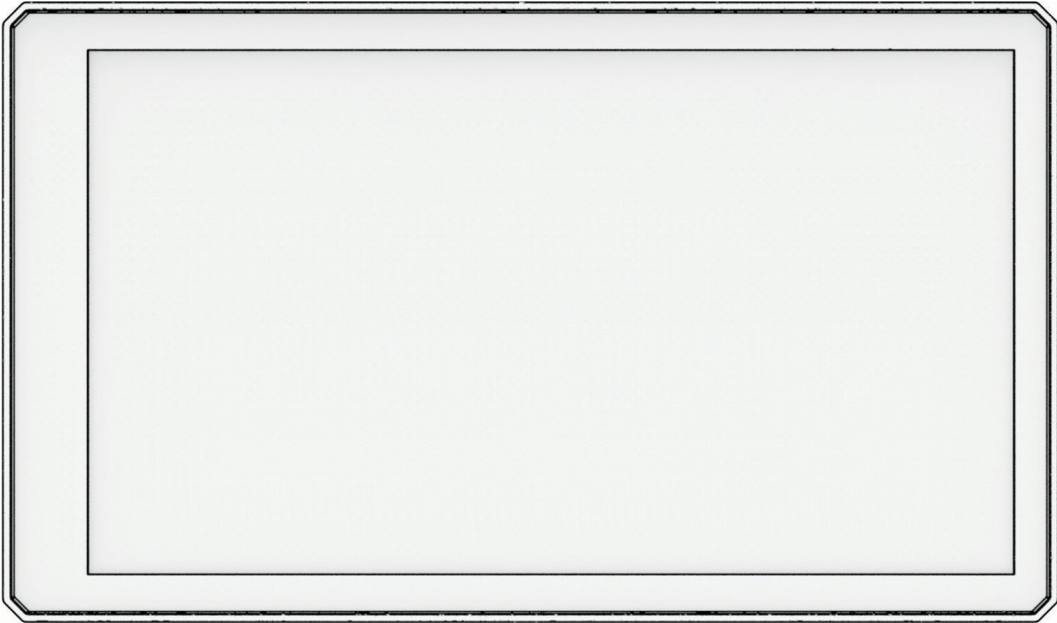

ZŪMO® XT2

Owner's Manual

© 2023 Garmin Ltd. or its subsidiaries

All rights reserved. Under the copyright laws, this manual may not be copied, in whole or in part, without the written consent of Garmin. Garmin reserves the right to change or improve its products and to make changes in the content of this manual without obligation to notify any person or organization of such changes or improvements. Go to www.garmin.com for current updates and supplemental information concerning the use of this product.

Garmin®, the Garmin logo, zūmo®, inReach®, TracBack®, and Tread® are trademarks of Garmin Ltd. or its subsidiaries, registered in the USA and other countries. BaseCamp™, Garmin Adventurous Routing™, Garmin Drive™, Garmin Explore™, Garmin Express™, Garmin PowerSwitch™, and myTrends™ are trademarks of Garmin Ltd. or its subsidiaries. These trademarks may not be used without the express permission of Garmin.

Android™ is a trademark of Google LLC. Apple® and Mac® are trademarks of Apple Inc., registered in the U.S. and other countries. The BLUETOOTH® word mark and logos are owned by the Bluetooth SIG, Inc., and any use of such name by Garmin is under license. Michelin® is a registered trademark of Michelin Travel Partner. microSD® and the microSD logo are trademarks of SD-3C, LLC. Tripadvisor® is a registered trademark of TripAdvisor LLC. Windows® is a registered trademark of Microsoft Corporation in the United States and other countries. Wi-Fi® is a registered trademark of Wi-Fi Alliance. Other trademarks and trade names are those of their respective owners.

Table of Contents

| | | | |
|---|-----------|---|-----------|
| Getting Started..... | 1 | Taking a Route Using Garmin Adventurous Routing™ | 11 |
| Device Overview | 1 | Changing the Route Calculation Mode | 12 |
| Turning the Device On or Off | 1 | Starting a Route by Using the Map... .. | 12 |
| Locking and Unlocking the Touchscreen | 2 | Going Home | 12 |
| Acquiring GPS Signals | 2 | Your Route on the Map | 13 |
| Status Bar Icons | 2 | Active Lane Guidance | 14 |
| Using the On-Screen Buttons | 3 | Viewing Turns and Directions | 14 |
| Adjusting the Volume | 3 | Viewing the Entire Route on the Map | 14 |
| Using the Audio Mixer | 3 | Arriving at Your Destination | 14 |
| Adjusting the Screen Brightness | 3 | Parking Near Your Destination | 15 |
| Changing the Keyboard | 3 | Ride Summary | 15 |
| Installation..... | 4 | Changing Your Active Route | 15 |
| Mounting Your Device in a Motorcycle | 4 | Adding a Location to Your Route | 15 |
| Powered Motorcycle Mount | 4 | Changing the Level of Adventurous Routing | 15 |
| Installing the Handlebar Base | 5 | Shaping Your Route | 16 |
| Attaching the Base Plate to the Handlebar Base | 6 | Taking a Detour | 16 |
| Installing Your Device in the Motorcycle Mount | 7 | Stopping the Route | 16 |
| Removing Your Device from the Motorcycle Mount | 7 | Avoiding Delays, Tolls, and Areas | 16 |
| Rider Awareness Features and Alerts..... | 7 | Avoiding Traffic Delays on Your Route | 16 |
| Enabling or Disabling Rider Alerts | 8 | Avoiding Toll Roads | 16 |
| Red Light and Speed Cameras | 8 | Avoiding Road Features | 16 |
| Incident Detection and Notifications | 8 | Custom Avoidances | 16 |
| Setting Up an Emergency Contact | 9 | Navigating Off Road | 17 |
| Cancelling an Incident Notification ... | 9 | Fuel Tracking | 17 |
| Disabling Incident Notifications | 9 | Enabling Fuel Tracking | 18 |
| inReach Remote | 9 | Setting a Low Fuel Warning | 18 |
| Connecting an inReach Device | 9 | Resetting the Fuel Tank Mileage | 18 |
| Sending an inReach Message | 10 | Enabling Dynamic Fuel Stops | 18 |
| Initiating an SOS Rescue | 10 | Finding and Saving Locations..... | 18 |
| Canceling an SOS Rescue | 10 | Finding a Location Using the Search Bar | 19 |
| Viewing Helmet Law Notifications | 10 | Points of Interest | 19 |
| Searching for Helmet Laws | 11 | Finding a Location by Category | 19 |
| Navigating to Your Destination..... | 11 | Navigating to Points of Interest Within a Venue | 19 |
| Routes | 11 | Viewing Your Garmin Explore™ | 20 |
| Starting a Route | 11 | Waypoints | 20 |
| | | Synchronizing Garmin Explore Account Data | 20 |
| | | Location Search Results | 20 |
| | | Location Search Results on the Map | 21 |

| | | | |
|---------------------------------------|-----------|--|-----------|
| Changing the Search Area..... | 22 | Viewing Upcoming Traffic..... | 28 |
| Parking..... | 22 | Viewing Traffic on the Map..... | 28 |
| Finding Parking Near Your Current | | Searching for Traffic Incidents..... | 28 |
| Location..... | 22 | Customizing the Map..... | 28 |
| Finding Parking Near a Specified | | Customizing the Map Layers..... | 28 |
| Location..... | 22 | Changing the Map Data Field..... | 28 |
| Search Tools..... | 22 | Changing the Map Buttons..... | 29 |
| Finding an Address..... | 22 | Changing the Map Perspective..... | 29 |
| Finding an Intersection..... | 22 | | |
| Finding a Location Using | | Live Services, Traffic, and | |
| Coordinates..... | 23 | Smartphone Features..... | 29 |
| Tripadvisor®..... | 23 | Pairing with Your Smartphone..... | 29 |
| Finding Tripadvisor Points of | | Pairing a Wireless Headset..... | 30 |
| Interest..... | 23 | Smart Notifications..... | 30 |
| Trendy Places..... | 23 | Receiving Notifications..... | 30 |
| Viewing Recently Found Locations..... | 23 | Viewing the List of Notifications..... | 31 |
| Clearing the List of Recently Found | | Hands-Free Calling..... | 31 |
| Locations..... | 23 | Placing a Call..... | 31 |
| Viewing Current Location | | Placing a Call Using Voice Dial..... | 32 |
| Information..... | 23 | Using In-Call Options..... | 32 |
| Finding Emergency Services and | | Disconnecting a Bluetooth Device..... | 32 |
| Fuel..... | 24 | Deleting a Paired Phone..... | 32 |
| Getting Directions to Your Current | | | |
| Location..... | 24 | Traffic..... | 32 |
| Adding a Shortcut..... | 24 | Receiving Traffic Data Using Your | |
| Removing a Shortcut..... | 24 | Smartphone..... | 32 |
| Saving Locations..... | 24 | Viewing Traffic on the Map..... | 33 |
| Saving a Location..... | 24 | Searching for Traffic Incidents..... | 33 |
| Saving a Location by Using the | | | |
| Map..... | 25 | Using the Apps..... | 33 |
| Saving Your Current Location..... | 25 | Group Ride..... | 33 |
| Editing a Saved Location..... | 25 | Starting a Group Ride..... | 33 |
| Deleting a Saved Location..... | 25 | Joining a Group Ride..... | 33 |
| | | Rejoining a Recent Group Ride..... | 33 |
| Using the Map..... | 26 | Adding Riders to a Radio Group | |
| Map Tools..... | 26 | Ride..... | 34 |
| Viewing a Map Tool..... | 26 | Broadcasting a Message..... | 34 |
| Up Ahead..... | 26 | Broadcasting a Location..... | 34 |
| Viewing Upcoming Locations..... | 27 | Viewing a Group Ride Notification... | 34 |
| Customizing the Up Ahead | | Exiting a Group Ride..... | 34 |
| Categories..... | 27 | Group Ride Settings..... | 35 |
| Cities Ahead..... | 27 | Radio..... | 35 |
| Viewing Upcoming Cities and Exit | | Selecting a Preset..... | 35 |
| Services..... | 27 | Selecting a Radio Channel..... | 35 |
| Trip Information..... | 27 | Adjusting the Squelch..... | 35 |
| Viewing Trip Data from the Map..... | 27 | Adding a Custom Radio Preset..... | 35 |
| Viewing the Trip Information Page.. | 27 | Selecting a Roger Tone..... | 36 |
| Resetting Trip Information..... | 28 | | |

| | | | |
|---|----|---|-----------|
| Turning the Radio Off..... | 36 | Viewing Weather Alerts..... | 45 |
| Enabling Push-to-Talk with a Headset..... | 36 | Checking Road Conditions..... | 45 |
| Transmitting Your Voice..... | 36 | Creating a Round-Trip Route..... | 46 |
| Adjusting the Radio Volume..... | 36 | Viewing Previous Routes and Destinations..... | 46 |
| Radio Settings..... | 36 | Settings..... | 46 |
| Garmin PowerSwitch™ App..... | 37 | Bluetooth Settings..... | 46 |
| Activating a Power Switch..... | 37 | Phone Settings..... | 46 |
| Turning Off All Switches..... | 37 | Headset Settings..... | 47 |
| Customizing a Button..... | 38 | Wi-Fi Settings..... | 47 |
| Assigning a Switch to a Control Input..... | 38 | Map Display Settings..... | 47 |
| Adding a Custom Layout..... | 38 | Enabling Maps..... | 47 |
| Routines..... | 39 | Navigation Settings..... | 47 |
| Great Rides..... | 40 | Traffic Settings..... | 48 |
| Bookmarking a Ride..... | 40 | Setting a Simulated Location..... | 48 |
| Synchronizing Great Rides..... | 41 | Driver Assistance Settings..... | 48 |
| Navigating a Bookmarked Ride..... | 41 | Display Settings..... | 48 |
| Enabling or Disabling the Great Rides Map Layer..... | 41 | System Settings..... | 49 |
| Viewing the Owner's Manual on Your Device..... | 41 | Setting the Time..... | 49 |
| Music Player..... | 41 | Device and Privacy Settings..... | 49 |
| Adding the Music Player Tool to the Map..... | 41 | Restoring Settings..... | 49 |
| Changing the Media Source..... | 42 | Device Information..... | 49 |
| BirdsEye Direct Satellite Imagery..... | 42 | Viewing E-label Regulatory and Compliance Information..... | 49 |
| Downloading BirdsEye Direct Satellite Imagery..... | 42 | Specifications..... | 50 |
| Route Planner..... | 42 | Charging the Device..... | 50 |
| Planning a Route..... | 43 | Device Maintenance..... | 50 |
| Editing and Reordering Locations in a Route..... | 43 | Garmin Support Center..... | 50 |
| Changing Routing Options for a Route..... | 43 | Map and Software Updates..... | 50 |
| Saving Your Active Route..... | 43 | Connecting to a Wi-Fi Network..... | 51 |
| Navigating to a Saved Route..... | 43 | Updating Maps and Software Using a Wi-Fi Network..... | 51 |
| Sharing a Route..... | 44 | Product Updates..... | 51 |
| Tracks..... | 44 | Device Care..... | 53 |
| Recording Tracks..... | 44 | Cleaning the Outer Casing..... | 53 |
| TracBack®..... | 44 | Cleaning the Touchscreen..... | 53 |
| Following Your Recent Track..... | 44 | Restarting the Device..... | 53 |
| Saving Your Recent Track as a Route..... | 44 | Removing the Device, Mount, and Suction Cup..... | 53 |
| Viewing the Weather Forecast..... | 45 | Removing the Device from the Mount..... | 53 |
| Viewing Weather Near a Different City..... | 45 | Removing the Mount from the Suction Cup..... | 53 |
| Viewing the Weather Radar..... | 45 | | |

| | |
|---|----|
| Removing the Suction Cup from the Windshield..... | 53 |
| Changing the Fuse in the Fuse Cable.. | 53 |

Troubleshooting..... 54

| | |
|--|----|
| My device is not acquiring satellite signals..... | 54 |
| My battery does not stay charged for very long..... | 54 |
| My device is not contacting my emergency contact..... | 54 |
| My device does not connect to my phone..... | 54 |
| The suction cup will not stay on my windshield..... | 54 |
| My device does not appear as either a portable device or a removable drive or volume on my computer..... | 55 |

Appendix..... 55

| | |
|--|----|
| Mounting Your Device in an Automobile..... | 55 |
| Garmin PowerSwitch..... | 56 |
| Mounting Considerations..... | 56 |
| Mounting the Device..... | 56 |
| Opening the Front Cover..... | 57 |
| Connecting Accessories..... | 58 |
| Connecting a Control Input..... | 59 |
| Connecting the Device to Vehicle Power..... | 59 |
| Pairing with a Garmin Navigation Device..... | 60 |
| Garmin PowerSwitch Specifications..... | 60 |
| My Garmin PowerSwitch will not stay connected..... | 60 |
| My accessories are not receiving power..... | 61 |
| Wireless Cameras..... | 61 |
| Pairing the Camera with a Garmin Navigation Device..... | 61 |
| Pairing a BC™ 50 Camera with a Garmin Navigation Device..... | 61 |
| Viewing the Wireless Camera..... | 62 |
| Installing a Memory Card for Maps and Data..... | 63 |
| Data Management..... | 63 |
| About Memory Cards..... | 63 |

| | |
|--|----|
| Connecting the Device to Your Computer..... | 63 |
| Transferring GPX Files From Your Computer..... | 63 |
| Transferring Data From Your Computer..... | 63 |
| Disconnecting the USB Cable..... | 64 |
| Adding BaseCamp™ Data to Garmin Explore..... | 64 |
| Viewing GPS Signal Status..... | 64 |
| Purchasing Additional Maps..... | 65 |

Getting Started

⚠ WARNING

See the *Important Safety and Product Information* guide in the product box for product warnings and other important information.

- 1 Connect to a Wi-Fi® network (*Connecting to a Wi-Fi Network*, page 51)(optional).
- 2 Pair your Bluetooth® phone and headset (*Pairing with Your Smartphone*, page 29) (optional).
- 3 Update the maps and software on your device (*Product Updates*, page 51).
- 4 Acquire GPS signals (*Acquiring GPS Signals*, page 2).
- 5 Mount the device and connect it to power (*Installation*, page 4).
- 6 Adjust the screen brightness (*Adjusting the Screen Brightness*, page 3).
- 7 Navigate to your destination (*Starting a Route*, page 11).

Device Overview

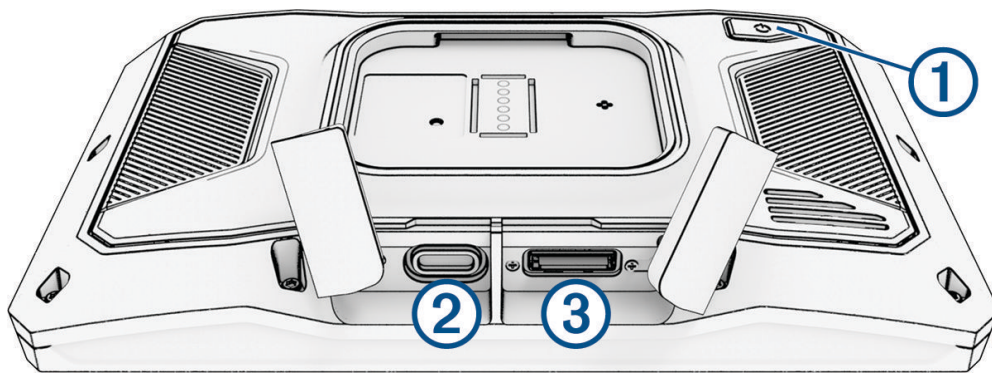

| | |
|---|---------------------------|
| ① | Power button |
| ② | USB power and data port |
| ③ | microSD® memory card slot |

Turning the Device On or Off

- To turn the device on, press the power button, or connect the device to power.
- To put the device in power saving mode, press the power button while the device is on.
While in power saving mode, the screen is off and the device uses very little power, but it can wake instantly for use.
TIP: You can charge your device faster by putting it in power saving mode while charging the battery.
- To turn off the device completely, hold the power button until a prompt appears on the screen, and select **Power Off**.
The prompt appears after five seconds. If you release the power button before the prompt appears, the device enters power saving mode.

Locking and Unlocking the Touchscreen

You can lock the touchscreen to prevent unwanted interaction during your ride. This can be useful during rain and other environmental situations that may affect the touchscreen.

- To lock the touchscreen, hold the power button until a prompt appears on the screen, and select **Lock Screen**.

The prompt appears after five seconds. If you release the power button before the prompt appears, the device enters power saving mode.

- To unlock the touchscreen, press the power button.

Acquiring GPS Signals









When you turn on your navigation device, the GPS receiver must collect satellite data and establish the current location. The time required to acquire satellite signals varies based on several factors, including how far you are from the location where you last used your navigation device, whether you have a clear view of the sky, and how long it has been since you last used your navigation device. The first time you turn on your navigation device, it may take several minutes to acquire satellite signals.

- 1 Turn on the device.
- 2 Wait while the device locates satellites.
- 3 If necessary, go to an open area, away from tall buildings and trees.

 in the status bar indicates the satellite signal strength. When at least half the bars are filled, the device is ready for navigation.







Status Bar Icons

The status bar is located at the top of the main menu. The status bar icons display information about features on the device. You can select some icons to change settings or view additional information.



| | |
|---|---|
|  | GPS signal status. Hold to view GPS accuracy and acquired satellite information (Viewing GPS Signal Status, page 64). |
|  | Bluetooth technology status. Select to view the Bluetooth settings (Bluetooth Settings, page 46). |
|  | Wi-fi signal strength. Select to change the wi-fi settings (Wi-Fi Settings, page 47). |
|  | Connected to hands-free calling. Select to place a phone call (Hands-Free Calling, page 31). |
|  | Current time. Select to set the time (Setting the Time, page 49). |
|  | Battery charge level. |
|  | Tread® app connection status (Pairing with Your Smartphone, page 29). |
|  | Temperature. Select to view the weather forecast (Viewing the Weather Forecast, page 45). |
|  | Fuel status. Select to view fuel tracking information (Fuel Tracking, page 17). |

Using the On-Screen Buttons

On-screen buttons allow you to navigate the pages, menus, and menu options on your device.

- Select  to return to the previous menu screen.
- Hold  to quickly return to the main menu.
- Select  or  to scroll through lists or menus.
- Hold  or  to scroll faster.
- Select  to see a context-based menu of options for the current screen.

Adjusting the Volume

- 1 Select .
- 2 Select an option:
 - Use the slider bar to adjust the volume.
 - Select  to mute the device.
 - Select a check box to enable or disable additional sound options.

Using the Audio Mixer

You can use the audio mixer to set the volume levels for different audio types, such as navigation prompts or phone calls. The level for each audio type is a percentage of the master volume.



- 1 Select .
- 2 Select **Mixer**.
- 3 Use the sliders to adjust the volume for each audio type.

Adjusting the Screen Brightness

- 1 Select  > **Display** > **Brightness**.
- 2 Use the slider bar to adjust the brightness.

Changing the Keyboard

Before you can change the keyboard language or layout, you must enable a keyboard language or layout in the system settings ([System Settings, page 49](#)).

- Select  to switch to a different keyboard language or layout.
- Select  or  to view more characters.

Installation

Mounting Your Device in a Motorcycle

Powered Motorcycle Mount

⚠ WARNING

See the *Important Safety and Product Information* guide in the product box for product warnings and other important information.

Garmin® strongly recommends having an experienced installer with the proper knowledge of electrical systems install the device. Incorrectly wiring the power cable can result in damage to the vehicle or the battery and can cause bodily injury.

NOTICE

Do not disassemble the device or motorcycle mount, because doing so could damage the device or mount.

The device must be mounted in a suitable and secure location on your motorcycle, based on available power sources and safe cable routing.

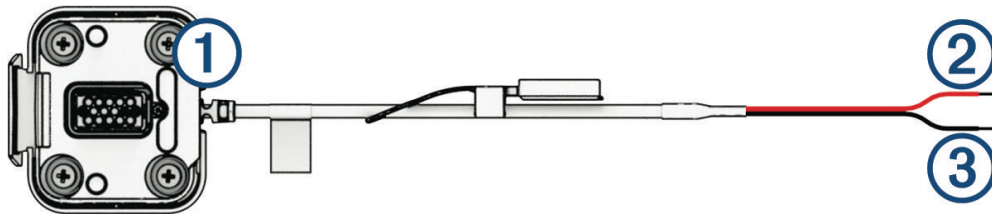

① Motorcycle mount connector

② 10 to 30 Vdc system power (red)

③ System ground (black)

NOTE: Additional parts are included with the device to provide more installation and wiring options. Contact an experienced installer for more information about using these parts with your motorcycle.

Crimp Style Ring Terminal: Connects the wiring harness directly to the battery terminal.

Cable Tie: Secures cables to the motorcycle frame.

In-line Fuse Cable: Protects the navigation device from excessive electrical current (*In-line Fuse Cable*, page 5).

In-line Fuse Cable

WARNING

Garmin strongly recommends having an experienced installer with the proper knowledge of electrical systems install the in-line fuse cable. Incorrectly wiring the power cable or the in-line fuse cable can result in damage to the vehicle or the battery and can cause bodily injury.

In many cases, you must install the included in-line fuse cable on the device power cable to protect the zūmo navigator from excessive electrical current.

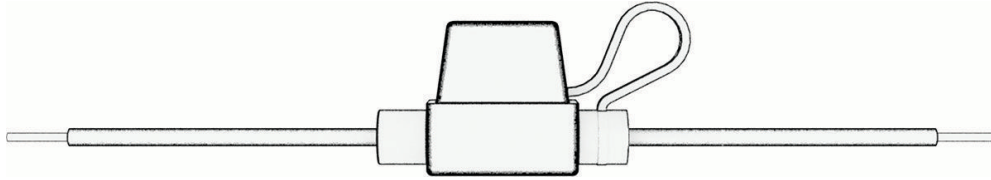



- You must install the included in-line fuse cable if you are connecting the power cable directly to the vehicle battery.
- If you are connecting the power cable to an accessory power source or bus bar that already has a suitable fuse or a protective circuit, installing the included in-line fuse is not necessary.
- When installing the fuse cable, you must connect it to the red system power cable using solder and heat-shrink tubing.

Installing the Handlebar Base

The device includes parts for two handlebar installation solutions. Custom mounts may require additional hardware.

Installing the U-bolt and Handlebar Base

- 1 Place the U-bolt  around the handlebar , and thread the ends through the handlebar base .

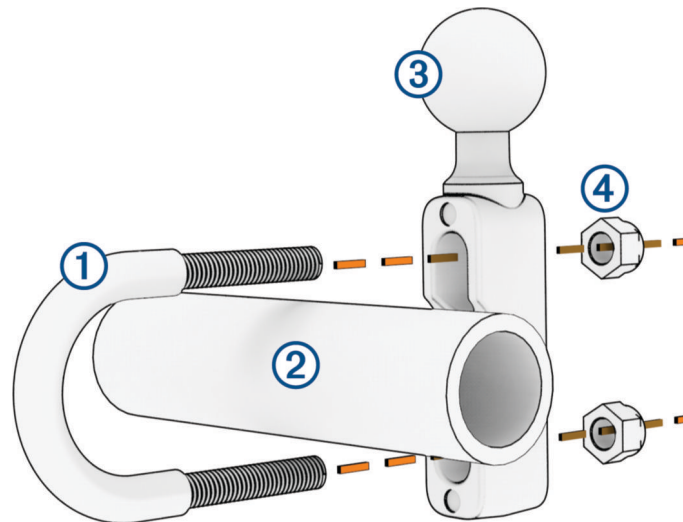

- 2 Tighten the nuts  to secure the base.
NOTE: The recommended torque is 50 lbf-in (5.65 N-m). Do not exceed a torque of 80 lbf-in (9.04 N-m).

Installing the Handlebar Base to the Clutch-Clamp or Brake-Clamp Brackets

- 1 Remove the two factory bolts on your clutch-clamp or brake-clamp bracket ①.

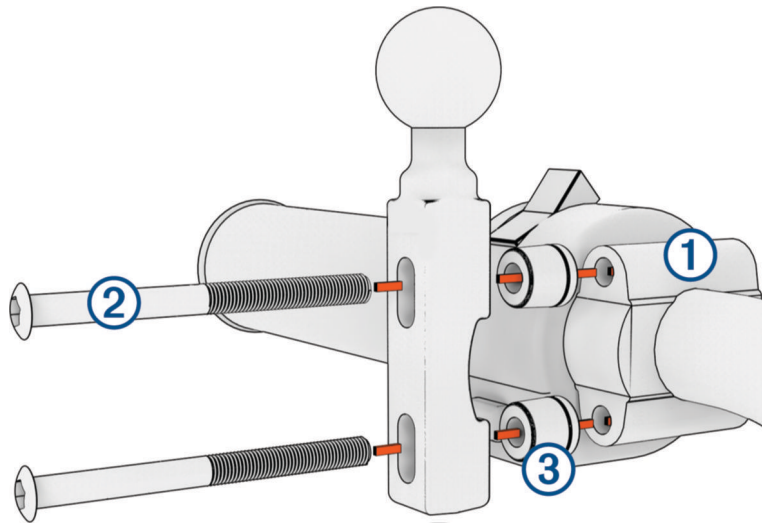

NOTE: Both $\frac{1}{4}$ in. standard and M6 bolts are included. Match the size of the factory bolts on your clutch-clamp or brake-clamp bracket.

- 2 Thread the new bolts ② through the handlebar base, spacers ③, and clutch-clamp or brake-clamp bracket.
- 3 Tighten the bolts to secure the handlebar base.

Attaching the Base Plate to the Handlebar Base

- 1 Align the ball of the handlebar base ① and the ball of the base plate ② with each end of the double-socket arm ③.

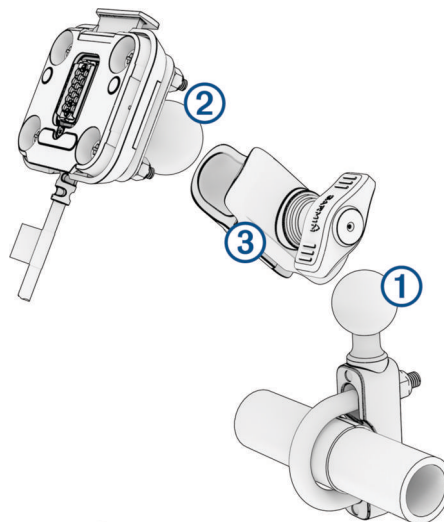

- 2 Insert the ball of the handlebar base ① and the ball of the base plate ② into the double-socket arm ③.
- 3 Tighten the knob slightly.
- 4 Adjust for optimal viewing and operation.
- 5 Tighten the knob to secure the mount.

Installing Your Device in the Motorcycle Mount

- 1 Fit the bottom of your device into the cradle.

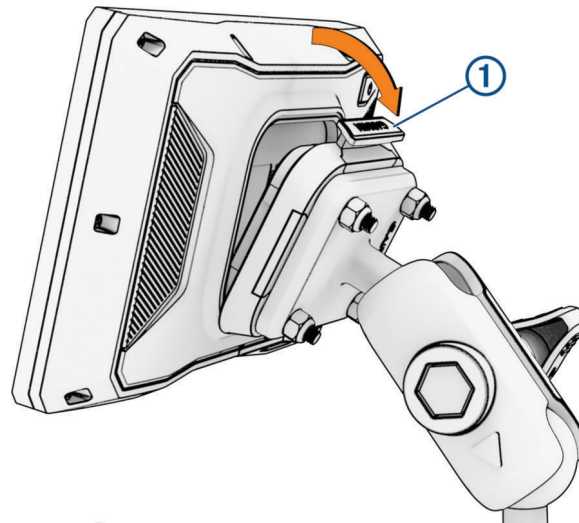

- 2 Push the top of the device forward until it snaps into place.
The latch ① on the mount stays up after you insert the device.

Removing Your Device from the Motorcycle Mount

- 1 Press the latch on the top of the mount.
- 2 Lift out the device.

Rider Awareness Features and Alerts

⚠ CAUTION

The rider alerts and speed limit features are for information only and do not replace your responsibility to abide by all posted speed limit signs and to use safe driving judgment at all times. Garmin is not responsible for any traffic fines or citations you receive for failing to follow all applicable traffic laws and signs.

Your device provides features that can help encourage safer riding, even when you are riding in a familiar area. The device plays an audible tone or message and displays information for each alert. You can enable or disable the audible tone or message for each type of alert. Not all alerts are available in all areas.

School zone or nearby school: The device plays a tone and displays the distance to and speed limit (if available) for an upcoming school or school zone.

Speed limit reduction: The device plays a tone and displays the upcoming reduced speed limit so you can be prepared to reduce your speed.

Speeding alert: The device displays a red border on the speed limit icon when you exceed the posted speed limit for the current road.

Railroad crossing: The device plays a tone and displays the distance to an upcoming railroad crossing.

Animal crossing: The device plays a tone and displays the distance to an upcoming animal crossing area.

Curve: The device plays a tone and displays the distance to a curve in the road.

Slower traffic: The device plays a tone and displays the distance to slower traffic when you approach slower traffic at a higher speed. Your device must be receiving traffic information to use this feature ([Receiving Traffic Data Using Your Smartphone, page 32](#)).

Break planning: The device plays a tone and suggests upcoming rest stops after you have been driving for more than two hours without stopping.

Enabling or Disabling Rider Alerts

You can turn off individual audible rider alerts. Visual alerts appear even when the audible alert is disabled.

- 1 Select  > **Driver Assistance** > **Rider Alerts**.
- 2 Select or clear the check box next to each alert.

Red Light and Speed Cameras

NOTICE

Garmin is not responsible for the accuracy of or the consequences of using a red light or speed camera database.

NOTE: This feature is not available for all regions or product models.

Information about red light and speed camera locations is available in some areas for some product models. The device alerts you when you approach a reported speed or red light camera.

- In some areas, your device can receive red light and speed camera data while connected to a smartphone running the Tread app.
- You can use the Garmin Express™ software (garmin.com/express) or the Tread app to update the camera database stored on your device. You should update your device frequently to receive the most up-to-date camera information.

Incident Detection and Notifications

WARNING

The device allows you to send your location to an emergency contact. This is a supplemental feature and should not be relied upon as a primary method to obtain emergency assistance. The Tread app does not contact emergency services on your behalf.

NOTICE

To use this feature, your device must be connected to the Tread app using Bluetooth technology. You can set emergency contacts using the Tread app.

To use this feature, your device must be connected to a compatible external power source using the included mount or a USB cable.

Your zūmo device uses built-in sensors to detect a possible vehicle incident.

- If you set up an emergency contact, the device can send an automated text message to that contact when it detects an incident and your vehicle stops moving. This can help alert the contact to your situation if you are not able to call or send a message. This feature requires your device to be connected to the Tread app using Bluetooth technology and your phone to have an active mobile data connection to send a message.
- If you have not set up an emergency contact, the device automatically displays the nearest address or geographic coordinates, if available, when it detects an incident. This feature is helpful if you need to tell emergency personnel your location.
- If you have an inReach® satellite communicator connected to your zūmo device, you can manually send an SOS when your zūmo device detects an incident.

Setting Up an Emergency Contact

Before you can set up an emergency contact, you must connect your navigation device to the Tread app ([Pairing with Your Smartphone](#), page 29).

The device must have access to the Tread app and to your smartphone phone book during the emergency contact setup. An emergency contact must be an existing contact on the smartphone paired with your zūmo device.

1 From the Tread app on your smartphone, select  > **Settings** > **Emergency Assistance** > **Continue**.

2 Read and accept the terms of use.

NOTE: You must accept the terms of use to use this feature.

3 Select **Add Emergency Contact**.

A list of your smartphone contacts appears.

4 Select a contact.

5 Select **Import** > **Save**.

6 Follow the on-screen instructions to inform your contact that you have added them as an emergency contact.

NOTE: The incident notification message includes the name or nickname you entered, but it is not sent from your phone number. The message is sent using a third-party service, and you should inform your emergency contact that the incident message will come from an unknown number.

Cancelling an Incident Notification

When the device detects an incident, a message and a voice prompt inform you that a notification will be sent to your emergency contact. A 60-second countdown timer starts when the incident is detected, and the device sends the notification automatically when the timer expires. If you do not want to send the notification, you can cancel it.

Before the timer expires, select **Cancel**.

Disabling Incident Notifications

While incident notifications are disabled, the device does not send an SMS notification when it detects an incident.

1 Select  > **Driver Assistance**.

2 Clear the **Automatic Incident Detection** check box.

inReach Remote

The inReach remote function allows you to control your inReach satellite communication device (sold separately) using your zūmo device. You can send messages, view weather reports, trigger an SOS alert, and more. Go to buy.garmin.com to purchase an inReach device.

Connecting an inReach Device

1 Bring the inReach device within 3 m (10 ft.) of your zūmo device.

2 On your zūmo device, select  > **inReach**.



3 Follow the on-screen instructions on your zūmo device to complete the pairing process.

After the pairing process is complete, the inReach and zūmo devices connect automatically when they are within range.

Sending an inReach Message

Before you can send an inReach message using your zūmo device, you must pair it with a compatible inReach device (*Connecting an inReach Device*, page 9).

You can use your device to send inReach messages to your contacts.

- 1 Select  > **inReach** > .
- 2 Select **New Message**.
- 3 Select **Select Contacts** to add one or more contacts.
- 4 Enter a message.
- 5 Select **Send**.



Initiating an SOS Rescue

WARNING

Before you can initiate an SOS rescue using your zūmo navigator, you must pair it with a compatible inReach satellite communicator (*Connecting an inReach Device*, page 9).

CAUTION

While the device is in SOS mode, do not turn off or attempt to turn off the inReach satellite communicator. Doing so could prevent this feature from operating properly and could delay receipt of assistance in the event of an emergency.

- 1 Select  > **inReach**.
- 2 Select .
- 3 Wait for the SOS countdown.
The device sends a default message to the emergency response service with details about your location.
- 4 Reply to the confirmation message from the emergency response service.
Your reply lets the emergency response service know that you are capable of interacting with them during the rescue.
For the first 10 minutes of your rescue, an updated location is sent to the emergency response service every minute. To conserve battery power after the first 10 minutes, an updated location is sent every 10 minutes when moving, and every 30 minutes when stationary.

Canceling an SOS Rescue

If you no longer need assistance, you can cancel an SOS rescue after it is sent to the emergency response service.

Select **Cancel SOS**.

Your device transmits the cancellation request. When you receive a confirmation message from the emergency response service, the device returns to normal operation.

Viewing Helmet Law Notifications

Helmet law and eye protection notifications may appear on your zūmo device the first time your device acquires satellites and when your device approaches a location with motorcycle safety rules.

NOTICE

Garmin recommends that all riders wear helmets for safety. Helmet law notifications are for reference only, are subject to change, and are not intended to be considered legal advice. Helmet law notifications are available in the U.S. and Canada only.

Select the notification to view more details.

Searching for Helmet Laws

You can search for helmet laws by state or province.

- 1 Select  > **Helmet Guide**.
- 2 Select a state or province.

Navigating to Your Destination

Routes

A route is a path from your current location to one or more destinations.

- The device calculates a recommended route to your destination based on the preferences you set, including the route calculation mode ([Changing the Route Calculation Mode, page 12](#)) and avoidances ([Avoiding Delays, Tolls, and Areas, page 16](#)).
- You can start navigating to your destination quickly using the recommended route, or you can select an alternate route ([Starting a Route, page 11](#)).
- If there are specific roads you need to use or avoid, you can customize the route.
- You can add multiple destinations to a route ([Adding a Location to Your Route, page 15](#)).

Starting a Route

- 1 Select **Where To?**, and search for a location.
- 2 Select a location.
- 3 Select an option:
 - To start navigating using the recommended route, select **Go!**.

The device calculates a route to the location and guides you using voice prompts and information on the map ([Your Route on the Map, page 13](#)). A preview of the major roads in your route appears at the edge of the map for several seconds.

If you need to stop at additional destinations, you can add the locations to your route ([Adding a Location to Your Route, page 15](#)).



Taking a Route Using Garmin Adventurous Routing™

Your device can calculate adventurous routes that prefer curvy roads, hills, and fewer highways. This feature can provide a more enjoyable ride, but it may increase the time or distance to your destination.

- 1 Select **Where To?**, and search for a location.
- 2 Select a location.
- 3 Select .
- 4 Use the slider to increase or decrease the level of adventure of your route.
- 5 Select **Go!**.

Changing Adventurous Route Settings

You can add and remove some types of paths, roads, and environmental features from adventurous routes.

- 1 Select **Where To?**, and search for a location.
- 2 Select a location.
- 3 Select  > .
- 4 Select or remove one or more route features, and select .

The navigator recalculates the route with the selected route features.

Changing the Route Calculation Mode

- 1 Select  > **Navigation** > **Calculation Mode**.
- 2 Select an option:
 - Select **Turn-by-Turn** to calculate routes on streets and trails.
 - Select **Straight Line** to calculate point-to-point routes (without roads).

Starting a Route by Using the Map

You can start a route by selecting a location from the map.

- 1 Select **View Map**.
- 2 Drag and zoom the map to display the area to search.
- 3 Select an option:
 - Select a location marker.
 - Select a point, such as a street, intersection, or address location.
- 4 Select **Go!**.

Going Home

The first time you start a route home, the device prompts you to enter your home location.

- 1 Select **Where To?** > **Go Home**.
- 2 If necessary, enter your home location.

Editing Your Home Location

- 1 Select **Where To?** >  > **Set Home Location**.
- 2 Enter your home location.

Your Route on the Map

As you travel, the device guides you to your destination using voice prompts and information on the map. Instructions for your next turn or exit, or other actions appear across the top of the map.

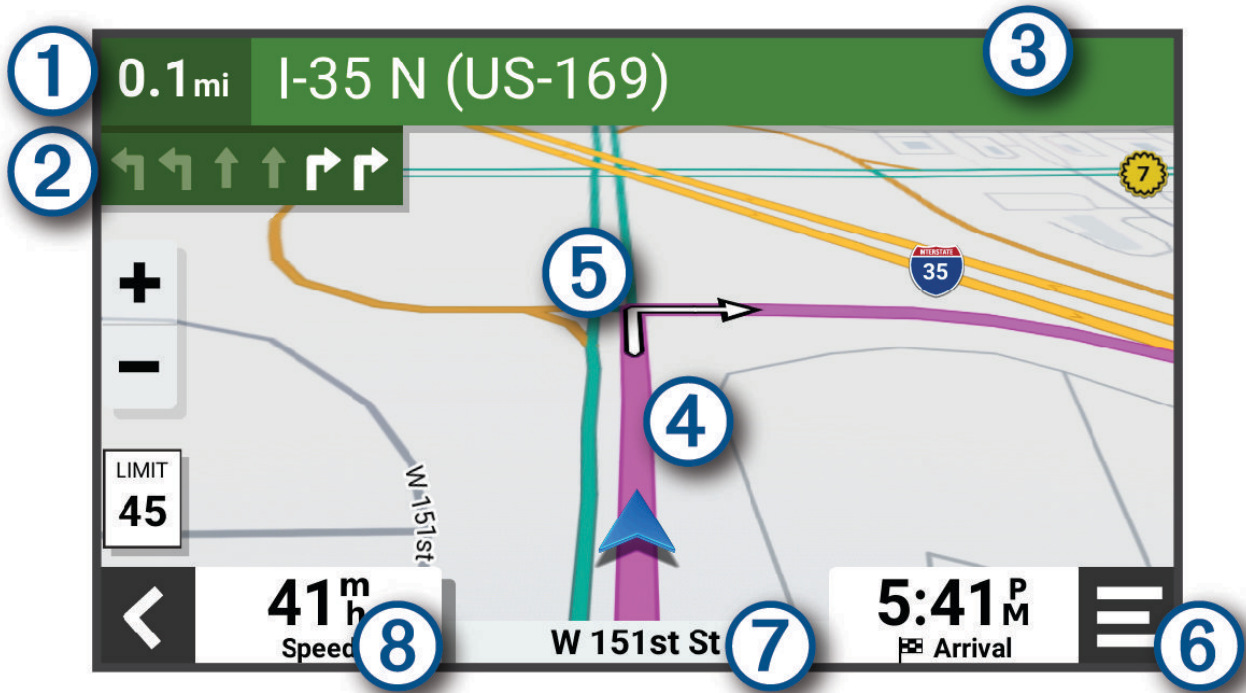

- | | |
|---|---|
| ① | Distance to the next action. |
| ② | Next action in the route. Indicates the next turn, exit, or other action and the lane in which you should travel, if available. |
| ③ | Name of the street or exit associated with the next action. |
| ④ | Route highlighted on the map. |
| ⑤ | Next action in the route. Arrows on the map indicate the location of upcoming actions. |
| ⑥ | Map tools. Provides tools to show you more information about your route and surroundings. |
| ⑦ | Name of the road on which you are traveling. |
| ⑧ | Vehicle speed. |

Active Lane Guidance

As you approach some turns, exits, or interchanges in your route, a detailed simulation of the road appears beside the map, if available. A colored line ① indicates the proper lane for the turn.

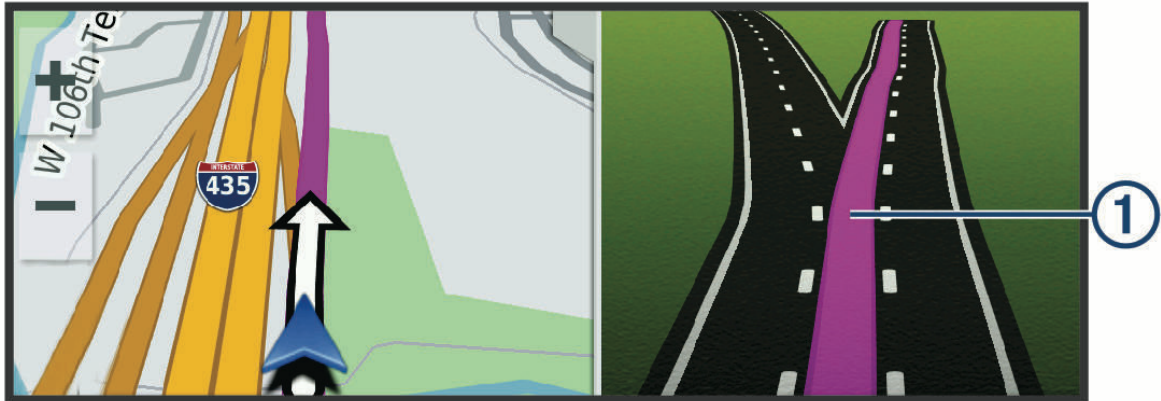

Viewing Turns and Directions

While navigating a route, you can view upcoming turns, lane changes, or other directions for your route.

- 1 From the map, select an option:
 - To view upcoming turns and directions as you navigate, select  > **Turns**.
The map tool displays the next several turns or directions beside the map. The list updates automatically as you navigate the route.
 - To view the complete list of turns and directions for the entire route, select the text bar at the top of the map.
- 2 Select a turn or direction (optional).
Detailed information appears. An image of the junction may appear for junctions on major roadways, if available.

Viewing the Entire Route on the Map

- 1 While navigating a route, select anywhere on the map.
- 2 Select .

Arriving at Your Destination

When you approach your destination, the device provides information to help you complete your route.

-  indicates the location of your destination on the map, and a voice prompt announces you are approaching your destination.
- When you approach some destinations, the device automatically prompts you to search for parking. You can select Yes to find nearby parking areas ([Parking Near Your Destination, page 15](#)).
- When you stop at your destination, the device automatically ends the route. If the device does not detect your arrival automatically, you can select Stop to end your route.

Parking Near Your Destination

Your device can help you find a parking spot near your destination. When you approach some destinations, the device automatically suggests parking areas.

1 Select an option:

- When the device suggests parking, select **More** to see all suggested parking areas.

NOTE: When you select a suggested parking area, the device automatically updates your route.

- If the device does not suggest parking locations, select **Where To? > Categories > Parking**, and select  **> My Destination**.

2 Select a parking location, and select **Go!**.

The device guides you to the parking area.

Ride Summary

When you arrive at your destination, the device displays a summary of your ride statistics. You can select Save to save the ride as a track.

NOTE: You can disable the ride summary in the settings menu (*Driver Assistance Settings*, page 48).

Changing Your Active Route

Adding a Location to Your Route

Before you can add a location to your route, you must be navigating a route (*Starting a Route*, page 11).

You can add locations to the middle or end of your route. For example, you can add a fuel station as the next destination in your route.

TIP: To create complex routes with multiple destinations or scheduled stops, you can use the route planner to plan, schedule, and save a route (*Planning a Route*, page 43).

1 From the map, select  **> Where To?**.

2 Search for a location.

3 Select a location.

4 Select **Go!**.

5 Select an option:

- To add the location as the next destination in your route, select **Add as Next Stop**.
- To add the location to the end of your route, select **Add as Last Stop**.
- To add the location and edit the order of destinations in your route, select **Add to Active Route**.

The device re-calculates the route to include the added location and guides you to the destinations in order.

Changing the Level of Adventurous Routing

You can change the level of adventurous routing without starting a new route.

1 From the map, select  **> Edit Route > Garmin Adventurous Routing™**.

2 Use the slider to increase or decrease the level of adventure for your route.

3 Select **Go!**.

Shaping Your Route

Before you can shape your route, you must start a route ([Starting a Route, page 11](#)).

You can manually shape your route to change its course. This allows you to direct the route to use a certain road or go through a certain area without adding a destination to the route.

- 1 From the map, select  > **Edit Route** > **Shape Route**.

The device enters route shaping mode.

- 2 Select a map location to create a shaping point.

TIP: You can select  to zoom in on the map and select a more precise location.

- 3 If necessary, select additional locations on the map to add more shaping points.
- 4 Select .

Taking a Detour

You can take a detour for a specified distance along your route or detour around specific roads. This is useful if you encounter construction zones, closed roads, or poor road conditions.

- 1 From the map, select  > **Edit Route**.

- 2 Select an option:

- To detour your route for a specific distance, select **Detour by Distance**.
- To detour around a specific road on the route, select **Detour by Road**.

Stopping the Route

From the map, select  > **Stop**.

Avoiding Delays, Tolls, and Areas

Avoiding Traffic Delays on Your Route

Before you can avoid traffic delays, you must be receiving traffic information ([Receiving Traffic Data Using Your Smartphone, page 32](#)).

By default, the device optimizes your route to avoid traffic delays automatically. If you have disabled this option in the traffic settings ([Traffic Settings, page 48](#)), you can view and avoid traffic delays manually.

- 1 While navigating a route, select  > **Traffic**.
- 2 Select **Alternate Route**, if available.
- 3 Select **Go!**.

Avoiding Toll Roads

Your device can avoid routing you through areas that require tolls, such as toll roads, toll bridges, or congestion areas. The device may still include a toll area in your route if no other reasonable routes are available.

- 1 Select  > **Navigation** > **Avoidances** > **Tolls and Fees**.
- 2 Select **Save**.

Avoiding Road Features

- 1 Select  > **Navigation** > **Avoidances**.
- 2 Select the road features to avoid on your routes, and select **Save**.

Custom Avoidances

Custom avoidances allow you to select specific areas or sections of road to avoid. When the device calculates a route, it avoids these areas and roads unless no other reasonable route is available.

Avoiding an Area



- 1 Select  > **Navigation** > **Custom Avoidances**.
- 2 If necessary, select **Add Avoidance**.
- 3 Select **Add Avoid Area**.
- 4 Select the upper-left corner of the area to avoid, and select **Next**.
- 5 Select the lower-right corner of the area to avoid, and select **Next**.
The selected area is shaded on the map.
- 6 Select **Done**.

Avoiding a Road



- 1 Select  > **Navigation** > **Custom Avoidances**.
- 2 If necessary, select **Add Avoidance**.
- 3 Select **Add Avoid Road**.
- 4 Select the starting point of the section of road to avoid, and select **Next**.
- 5 Select the ending point of the road section, and select **Next**.
- 6 Select **Done**.

Disabling a Custom Avoidance

You can disable a custom avoidance without deleting it.

- 1 Select  > **Navigation** > **Custom Avoidances**.
- 2 Select an avoidance.
- 3 Select  > **Disable**.

Deleting Custom Avoidances

- 1 Select  > **Navigation** > **Custom Avoidances** > .
- 2 Select an option:
 - To delete all custom avoidances, select **Select All** > **Delete**.
 - To delete one custom avoidance, select the avoidance, and select **Delete**.

Navigating Off Road

If you are not following roadways as you navigate, you can use Straight Line mode.

Select  > **Navigation** > **Calculation Mode** > **Straight Line** > **Save**.

The device ignores roads and calculates routes using straight lines between destinations.

Fuel Tracking

You can set your device to estimate your fuel usage, warn you when you approach the maximum estimated fuel distance, and suggest fuel stops based on your estimated fuel range. When fuel tracking is enabled,  indicates the current fuel status.

White: Fuel tracking is disabled, or the device is not connected to the motorcycle mount.

Green: The estimated fuel range is above the fuel tank warning level.

Yellow: The estimated fuel range is below the fuel tank warning level.

Red: The estimated distance remaining on the tank is 0.

Enabling Fuel Tracking

Before you can enable fuel tracking, the device must be placed in the motorcycle mount.

When you enable fuel tracking, a fuel gauge appears on the trip computer ([Viewing the Trip Information Page, page 27](#)).

- 1 Fill your fuel tank.
- 2 Select  > **Fuel Settings** > **Fuel Tracking**.
- 3 Select **Distance Per Tank**.
- 4 Enter the distance the vehicle travels on a tank of gas and select **Done**.

Setting a Low Fuel Warning

You can set the device to warn you when the tank is low on fuel.

NOTE: The device must be connected to the motorcycle mount to give low fuel warnings.

- 1 Enable fuel tracking ([Enabling Fuel Tracking, page 18](#)).
- 2 Select **Remaining Fuel Warning**.
- 3 Enter a distance, and select **Done**.

When you have only enough fuel left to travel the distance you entered, a low fuel warning appears on the map page.

Resetting the Fuel Tank Mileage

When you refill your fuel tank, you should reset the fuel tank mileage on your device to more accurately track your remaining fuel.

Select  > **Fuel Settings** > **Reset Fuel Tank**.

Enabling Dynamic Fuel Stops

Before you can enable dynamic fuel stops, the device must be in motorcycle mode, placed in the motorcycle mount, and fuel tracking must be enabled.

You can set the device to suggest fuel stops based on your estimated fuel range.

Select  > **Fuel Settings** > **Dynamic Fuel Stops**.

Finding and Saving Locations

The maps loaded in your device contain locations, such as restaurants, hotels, auto services, and detailed street information. The Where To? menu helps you find your destination by providing several methods to browse, search, and save this information.

- Enter search terms to quickly search all location information ([Finding a Location Using the Search Bar, page 19](#)).
- Browse or search pre-loaded points of interest by category ([Points of Interest, page 19](#)).
- Use search tools to find specific locations, such as addresses, intersections, or geographic coordinates ([Search Tools, page 22](#)).
- Search near a different city or area ([Changing the Search Area, page 22](#)).
- Save your favorite locations to find them quickly in the future ([Saving Locations, page 24](#)).
- Return to recently found locations ([Viewing Recently Found Locations, page 23](#)).

Finding a Location Using the Search Bar

You can use the search bar to search for locations by entering a category, brand name, address, or city name.

- 1 Select **Where To?**.
- 2 Select **Search** in the search bar.
- 3 Enter all or part of the search term.
Suggested search terms appear below the search bar.
- 4 Select an option:
 - To search for a type of business, enter a category name (for example, "movie theaters").
 - To search for a business name, enter all or part of the name.
 - To search for an address near you, enter the house number and street name.
 - To search for an address in another city, enter the house number, street name, city, and state.
 - To search for a city, enter the city and state.
 - To search for coordinates, enter latitude and longitude coordinates.
- 5 Select an option:
 - To search using a suggested search term, select the term.
 - To search using the text you entered, select **Q**.
- 6 If necessary, select a location.

Points of Interest

NOTICE

You are responsible for understanding and complying with any applicable rules, laws, or regulations associated with points of interest.

A point of interest is a place that you may find useful or interesting. Points of interest are organized by category and can include popular travel destinations such as gas stations, restaurants, hotels, and entertainment venues.

Finding a Location by Category

- 1 Select **Where To?**.
- 2 Select a category, or select **Categories**.
- 3 If necessary, select a subcategory.
- 4 Select a location.

Navigating to Points of Interest Within a Venue

NOTE: This feature may not be available in all areas or for all product models.

You can create a route to a point of interest (POI) within a larger venue, such as a store in a shopping mall or a specific terminal in an airport.

- 1 Select **Where To? > Search**.
- 2 Select an option:
 - To search for the venue, enter the name or address of the venue, select **Q**, and go to step 3.
 - To search for the POI, enter the name of the POI, select **Q**, and go to step 5.
- 3 Select the venue.
A list of categories appears below the venue, such as restaurants, car rentals, or terminals.
- 4 Select a category.
- 5 Select the POI, and select **Go!**.

The device creates a route to the parking area or venue entrance closest to the POI. When you arrive at the destination, a checkered flag indicates the recommended parking area. A labeled point indicates the location of the POI within the venue.

Exploring a Venue

NOTE: This feature may not be available in all areas or for all product models.

You can view a list of all points of interest located within each venue.

- 1 Select a venue.
- 2 Select  > **Explore this Venue.**

Viewing Your Garmin Explore™ Waypoints

- 1 Select  > **Explore.**
- 2 Select a data type.
- 3 Select an item to view the details.

Synchronizing Garmin Explore Account Data

Before you can synchronize account data, you must connect to the Tread app and enable Garmin Explore.

You can synchronize data, such as tracks, with your Garmin Explore account. This can be helpful to keep your data available on each of your compatible devices. Your device periodically synchronizes data with your account automatically. You can also synchronize data manually at any time.

- 1 Select  > **Explore.**
- 2 Select .





Location Search Results

By default, the location search results appear in a list, with the nearest location at the top. You can scroll down to view more results.



The screenshot shows a search interface with a search bar containing "Johnson County Library". Below the search bar, there are three search results. The first result is highlighted with a blue circle labeled "1" and a blue circle labeled "5". The second and third results are also visible. The interface includes a search bar, a list of results, and a navigation bar with icons for search, info, and navigation.

| Search Result | Address | Distance | Direction |
|-------------------------------|--------------------------------------|----------|-----------|
| Johnson County Library | 9875 W 87th St, Overland Park, KS | 0.2mi | SE |
| Johnson County Library | 8100 Mission Rd, Prairie Village, KS | 3.9mi | E |
| Johnson County Library | 137 E Shawnee St, Gardner, KS | 16mi | SW |



| | |
|---|--|
| ① | Select a location to view the option menu. |
| ②  | Select to view detailed information about the selected location. |
| ③  | Select to start navigating to the location using Garmin Adventurous Routing. |
| ④  | Select to start navigating to the location using the recommended route. |
| ⑤  | Select to view the search results on the map. |

Location Search Results on the Map

You can view the results of a location search on the map instead of in a list.

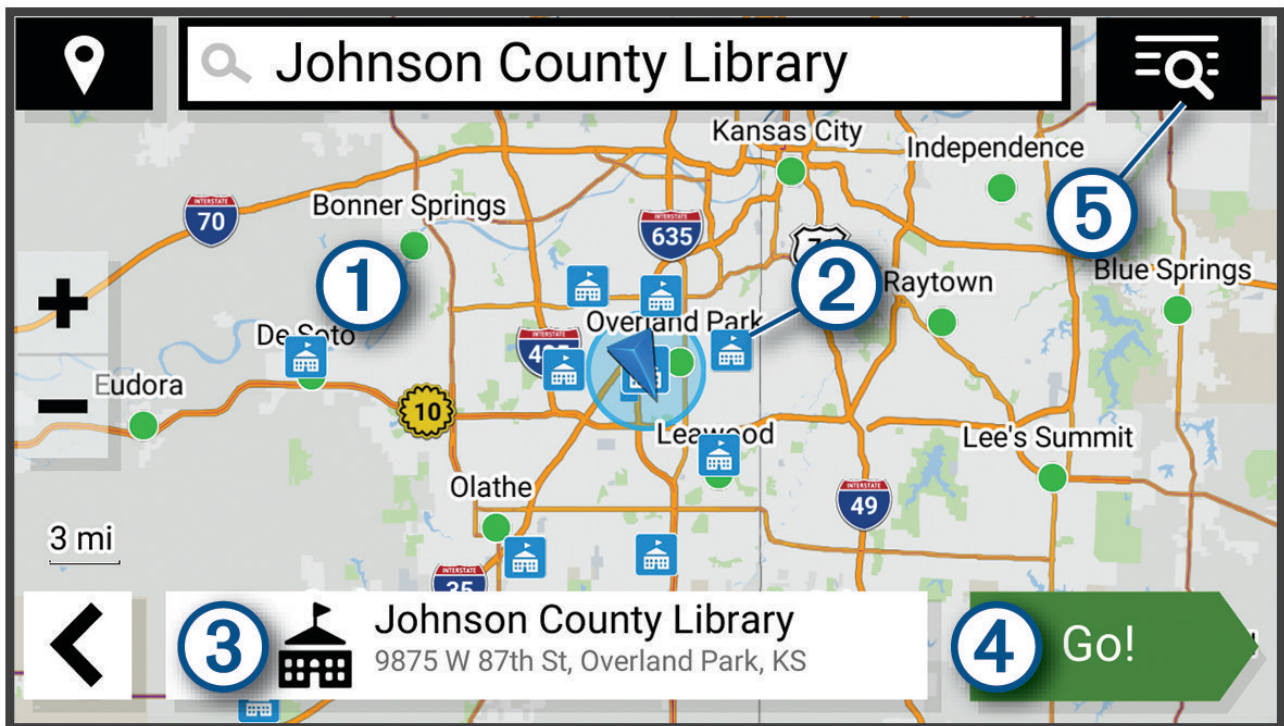

From the location search results, select . The nearest location appears at the center of the map, and basic information about the selected location appears at the bottom of the map.



| | |
|---|---|
| ① | Drag the map to view additional search results. |
| ② | Additional search results. Select to view another location. |
| ③ | Selected location summary. Select to view detailed information about the selected location. |
| ④  | Select to start navigating to the location using the recommended route. |
| ⑤  | Select to view the search results in a list. |

Changing the Search Area

By default, the device searches for locations near your current location. You can also search other areas, such as near your destination, near another city, or along your active route.

- 1 Select **Where To?**.
- 2 Select  next to the current search area .

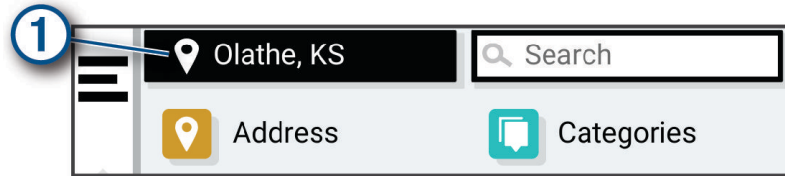

- 3 Select a search area.
- 4 If necessary, follow the on-screen instructions to select a specific location.

The selected search area appears next to . When you search for a location using any of the options in the Where To? menu, the device suggests locations near this area first.

Parking

Finding Parking Near Your Current Location

- 1 Select **Where To? > Categories > Parking**.
- 2 Select a parking location.
- 3 Select **Go!**.

Finding Parking Near a Specified Location

- 1 Select **Where To?**.
- 2 Search for a location.
- 3 From the location search results, select a location.
- 4 Select  **> Parking**.
A list of parking areas near the selected location appears.
- 5 Select a parking location.
- 6 Select **Go!**.

Search Tools

Search tools allow you to search for specific types of locations by responding to on-screen prompts.

Finding an Address

NOTE: The order of the steps may change depending on the map data loaded on your device.

- 1 Select **Where To?**.
- 2 If necessary, select  to search near a different city or area.
- 3 Select **Address**.
- 4 Follow the on-screen instructions to enter address information.
- 5 Select the address.

Finding an Intersection

You can search for an intersection or junction between two streets, highways, or other roads.

- 1 Select **Where To? > Intersections**.
- 2 Follow the on-screen instructions to enter street information.
- 3 Select the intersection.

Finding a Location Using Coordinates

You can find a location using latitude and longitude coordinates.

- 1 Select **Where To? > Coordinates**.
- 2 If necessary, select , and change the coordinate format or datum.
- 3 Enter the latitude and longitude coordinates.
- 4 Select **View on Map**.

Tripadvisor

NOTICE

Garmin is not responsible for the accuracy or timeliness of the Tripadvisor information.

You are responsible for understanding and complying with any applicable rules, laws, or regulations associated with points of interest.

Your device includes Tripadvisor traveler ratings. Tripadvisor ratings appear automatically in the search results list for restaurants, hotels, and attractions. You can also search for nearby Tripadvisor points of interest and sort by distance or popularity.

Finding Tripadvisor Points of Interest

- 1 Select **Where To? > Tripadvisor**.
- 2 Select a category.
- 3 If necessary, select a subcategory.
A list of nearby Tripadvisor points of interest for the category appears.
- 4 Select **Sort Results** to filter the displayed points of interest by distance or popularity (optional).
- 5 Select , and enter a search term (optional).

Trendy Places

NOTICE

Garmin is not responsible for the accuracy or timeliness of the Tripadvisor or Michelin® information. You are responsible for understanding and complying with any applicable rules, laws, or regulations associated with points of interest.

The Trendy Places search feature includes both Tripadvisor and Michelin points of interest and ratings, providing a comprehensive list of attractions. You can filter the search results by categories, ratings, and distance from the route.

NOTE: Tripadvisor and Michelin points of interest are not available in all areas.

Viewing Recently Found Locations

Your device stores a history of the last 50 locations you have found.

Select **Where To? > Recent**.

Clearing the List of Recently Found Locations

Select **Where To? > Recent >  > Clear > Yes**.

Viewing Current Location Information

You can use the **Where Am I?** page to view information about your current location. This feature is helpful if you need to tell emergency personnel your location.

From the map, select the vehicle.

Finding Emergency Services and Fuel

You can use the Where Am I? page to find the nearest hospitals, police stations, and fuel stations.

1 From the map, select the vehicle.

2 Select **Hospitals**, **Police Stations**, or **Fuel**.

NOTE: Some service categories are not available in all areas.

A list of locations for the selected service appears, with the nearest locations at the top.

3 Select a location.

4 Select an option:

- To navigate to the location, select **Go!**.
- To view the phone number and other location details, select **i**.

Getting Directions to Your Current Location

If you need to tell another person how to get to your current location, your device can give you a list of directions.

1 From the map, select the vehicle.

2 Select  > **Directions to Me**.

3 Select a starting location.

4 Select **Select**.

Adding a Shortcut

You can add shortcuts to the Where To? menu. A shortcut can point to a location, a category, or a search tool.

The Where To? menu can contain up to 36 shortcut icons.

1 Select **Where To?** > **Add Shortcut**.

2 Select an item.

Removing a Shortcut

1 Select **Where To?** >  > **Remove Shortcut(s)**.

2 Select a shortcut to remove.

3 Select the shortcut again to confirm.

4 Select **Done**.

Saving Locations

Saving a Location

1 Search for a location (*Finding a Location by Category*, page 19).

2 From the search results, select a location.

3 Select **i** > **Save**.

4 If necessary, enter a name, and select **Done**.

5 Select **Save**.

Saving a Location by Using the Map



You can save a location by selecting a location from the map.

- 1 Select **View Map**.
- 2 Drag and zoom the map to display the area to search.
- 3 Select a point, such as a street, intersection, or address location.
- 4 Select **Save**.
- 5 Select one or more options:
 - To change the name of a location, select **Name**, and enter a name.
 - To change the location marker, select **Map Symbol**.
 - To assign a collection category, select **Collections**.
- 6 Select **Done**.

Saving Your Current Location

- 1 From the map, select the vehicle icon.
- 2 Select **Save**.
- 3 Enter a name, and select **Done**.
- 4 Select **Save > OK**.

Editing a Saved Location

- 1 Select **Where To? > Saved**.
- 2 If necessary, select a category.
- 3 Select a location.
- 4 Select .
- 5 Select  **> Edit**.
- 6 Select an option:
 - Select **Name**.
 - Select **Phone Number**.
 - Select **Categories** to assign categories to the saved location.
 - Select **Change Map Symbol** to change the symbol used to mark the saved location on a map.
- 7 Edit the information.
- 8 Select **Done**.

Deleting a Saved Location

NOTE: Deleted locations cannot be recovered.

- 1 Select **Where To? > Saved**.
- 2 Select  **> Delete Saved Places**.
- 3 Select the box next to the saved locations to delete, and select **Delete**.

Using the Map

You can use the map to navigate a route ([Your Route on the Map, page 13](#)) or to view a map of your surroundings when no route is active.

- 1 Select **View Map**.
- 2 Touch anywhere on the map.
- 3 Select an option:
 - Drag the map to pan left, right, up, or down.
 - To zoom in or out, select **+** or **-**.
 - To switch between North Up and 3-D views, select **▲**.
 - To filter the displayed points of interest by category, select **Q**.
 - To start a route, select a location on the map, and select **Go!** ([Starting a Route by Using the Map, page 12](#)).

Map Tools

Map tools provide quick access to information and device functions while you view the map. When you activate a map tool, it appears in a panel at the edge of the map.

Stop: Stops navigation of the active route.

Edit Route: Allows you to take a detour or skip locations in your route ([Changing Your Active Route, page 15](#)).

Mute: Mutes the device audio.

Cities Ahead: Displays upcoming cities and services along your active route or along a highway.

Up Ahead: Displays upcoming locations along the route or the road on which you are traveling ([Up Ahead, page 26](#)).

Elevation: Displays upcoming elevation changes.

Traffic: Displays traffic conditions along your route or in your area ([Viewing Upcoming Traffic, page 28](#)). This feature is not available in all areas or for all device models.

Trip Data: Displays customizable trip data, such as speed or mileage ([Viewing Trip Data from the Map, page 27](#)).

Track Recorder: Displays the track data for your active track.

Turns: Displays a list of upcoming turns in your route ([Viewing Turns and Directions, page 14](#)).

Phone: Displays a list of recent phone calls from your connected phone, and displays in-call options while a phone call is active.

Weather: Displays weather conditions for your area.

Music Player: Displays media controls and media information.

Group Ride: Displays the distance and direction of the members in your group ride ([Group Ride, page 33](#)).

Radio: Allows you to use the push-to-talk feature with a compatible Bluetooth headset ([Enabling Push-to-Talk with a Headset, page 36](#)).

Viewing a Map Tool

- 1 From the map, select **☰**.
- 2 Select a map tool.
The map tool appears in a panel at the edge of the map.
- 3 When you are done using the map tool, select **✕**.

Up Ahead

The Up Ahead tool provides information about upcoming locations along your route or the road on which you are traveling. You can view upcoming points of interest by category, such as restaurants, fuel stations, or rest areas.

You can customize three categories to show in the Up Ahead tool.

Viewing Upcoming Locations

- 1 From the map, select  > **Up Ahead**.

While you are traveling, the map tool shows the next location along your road or route.

- 2 Select an option:

- If the map tool shows categories, select a category to view a list of nearby locations in that category.
- If the map tool shows upcoming locations, select a location to view location details or start a route to the location.

Customizing the Up Ahead Categories

You can change the location categories that appear in the Up Ahead tool.

- 1 From the map, select  > **Up Ahead**.

- 2 Select a category.

- 3 Select .

- 4 Select an option:

- To move a category up or down in the list, select and drag the arrow next to the category name.
- To change a category, select the category.
- To create a custom category, select a category, select **Custom Search**, and enter the name of a business or category.

- 5 Select **Save**.

Cities Ahead

While you are traveling on a highway or navigating a route that includes a highway, the Cities Ahead tool provides information about upcoming cities along the highway. For each city, the map tool shows the distance to the highway exit and the services available, similar to the information on highway road signs.

Viewing Upcoming Cities and Exit Services

- 1 From the map, select  > **Cities Ahead**.

While you are traveling along a highway or an active route, the map tool shows information about upcoming cities and exits.

- 2 Select a city.

The device shows a list of points of interest located at the selected city exit, such as fuel stations, lodging, or restaurants.

- 3 Select a location, and select **Go!** to start navigating.

Trip Information

Viewing Trip Data from the Map

From the map, select  > **Trip Data**.

Customizing the Trip Data Fields

- 1 From the map, select  > **Trip Data**.

- 2 Select a trip data field.

- 3 Select an option.

The new trip data field appears in the trip data map tool.

Viewing the Trip Information Page

The trip information page displays your speed and provides statistics about your trip.

From the map, select **Speed**.

Resetting Trip Information

- 1 From the map, select **Speed**.
- 2 Select  > **Reset Field(s)**.
- 3 Select an option:
 - When not navigating a route, select **Select All** to reset every data field except the speedometer, on the first page.
 - Select **Reset Overall Data** to reset the information on the trip computer.
 - Select **Reset Max. Speed** to reset the maximum speed.
 - Select **Reset Trip B** to reset the odometer.

Viewing Upcoming Traffic

NOTICE

Garmin is not responsible for the accuracy or timeliness of the traffic information.



Before you can use this feature, your device must be receiving traffic data ([Traffic](#), page 32).

You can view traffic incidents coming up along your route or along the road on which you are traveling.



- 1 While navigating a route, select  > **Traffic**.
The nearest upcoming traffic incident appears in a panel on the right side of the map.
- 2 Select the traffic incident to view additional details.

Viewing Traffic on the Map

The traffic map shows color-coded traffic flow and delays on nearby roads.

- 1 From the main menu, select  > **Traffic**.
- 2 If necessary, select  > **Legend** to view the legend for the traffic map.

Searching for Traffic Incidents

- 1 From the main menu, select  > **Traffic**.
- 2 Select  > **Incidents**.
- 3 Select an item in the list.
- 4 If there is more than one incident, use the arrows to view additional incidents.

Customizing the Map

Customizing the Map Layers

You can customize which data appear on the map, such as icons for points of interest and road conditions.

- 1 Select  > **Map Display** > **Map Layers**.
- 2 Select the layers to include on the map, and select **Save**.

Viewing Popular Motorcycle Paths on the Map

You can enable the device to highlight popular motorcycle paths on the map. This can help you choose roads that provide a more enjoyable ride.

From the map, select  > **Popular Paths (Moto)**.

Changing the Map Data Field

- 1 From the map, select a data field.
NOTE: You cannot customize Speed.
- 2 Select a type of data to display.

Changing the Map Buttons

- 1 From the map, hold a map button.
- 2 Select an option:
 - To replace a map button, select a map button, and select a map button to display.
 - To remove a map button, select .
- 3 Select **Save**.

Changing the Map Perspective

- 1 Select  > **Map Display** > **Driving Map View**.
- 2 Select an option:
 - Select **Track Up** to display the map in two dimensions (2-D), with your direction of travel at the top.
 - Select **North Up** to display the map in 2-D with north at the top.
 - Select **3-D** to display the map in three dimensions.
- 3 Select **Save**.

Live Services, Traffic, and Smartphone Features

WARNING

Do not read or interact with notifications while driving, because doing so can cause distraction which could lead to an accident resulting in serious personal injury or death.

NOTICE

Garmin is not responsible for the accuracy or timeliness of the traffic information.

The Tread app allows your device to receive smart notifications and live information, such as live traffic data and weather information.

Live traffic data: Sends live traffic data to your device, such as traffic incidents and delays, construction zones, and road closings (*Traffic*, page 32).

Weather information: Sends real-time weather forecasts, road conditions, and weather radar to your device (*Viewing the Weather Forecast*, page 45).

Smart Notifications: Displays phone notifications and messages on your device. This feature is not available for all languages.

Hands-Free calling: Allows you to place and receive phone calls through the device using your connected Bluetooth headset.

Send locations to device: Allows you to send locations from your smartphone to your navigation device.

Pairing with Your Smartphone

You can pair your zūmo navigator with your smartphone and the Tread app to enable additional features and access live information (*Live Services, Traffic, and Smartphone Features*, page 29).

- 1 Turn on your zūmo navigator, and place the navigator and your smartphone within 3 m (10 ft.) of each other.
- 2 From your zūmo navigator, select  > **Phone** > **Add a Phone**.
- 3 Using your phone, scan the QR code to download and install the Tread app.
TIP: You can use the camera app on most phones to scan the QR code.
- 4 Follow the on-screen instructions to sign in to a Garmin account and complete the pairing and setup process.

The main app dashboard appears. After the devices are paired, you can enable or disable smartphone features on your navigator (*Phone Settings*, page 46). The devices connect automatically when they are turned on and within range.

Pairing a Wireless Headset

NOTE: Only one headset can receive navigation prompts and phone calls at a time. Up to two headsets can be used for multimedia audio.

- 1 Place your headset and your navigation device within 33 ft. (10 m) of each other.
- 2 On your navigation device, select  > **Headset** > **Add Headset**.
- 3 On your headset, enable Bluetooth wireless technology and make it visible to other Bluetooth devices.
- 4 Follow the on-screen instructions on your navigation device to complete the pairing process.

After the pairing process is complete, you can enable or disable features for your paired wireless headset (*Headset Settings*, page 47).

Smart Notifications

While your device is connected to the Tread app, you can view notifications from your smartphone on your zūmo device, such as text messages, incoming calls, and calendar appointments.

NOTE: You may need to wait a few minutes to receive notifications on your navigation device after it connects to the Tread app.  appears colored in the Bluetooth settings when smart notifications are connected and active.

Receiving Notifications

WARNING

Do not read or interact with notifications while driving, because doing so can cause distraction that could lead to an accident resulting in serious personal injury or death.

Before you can use this feature, your device must be connected to a supported phone running the Tread app (*Pairing with Your Smartphone*, page 29).

From most pages, a popup appears when the device receives a notification from your smartphone. If the device is moving, you must verify you are a passenger and not the driver before you can view notifications.

NOTE: If you are viewing the map, notifications appear in a map tool.

- To ignore a notification, select **OK**.
The popup closes, but the notification remains active on your phone.
- To view a notification, select **View**.
- To listen to the notification, select **View** > **Play**.
The device reads the notification using text-to-speech technology. This feature is not available for all languages.
- To perform additional actions, such as dismissing the notification from your phone, select **View**, and select an option.

NOTE: Additional actions are available for only some notification types and must be supported by the app generating the notification.

Receiving Notifications while Viewing the Map

WARNING

Do not read or interact with notifications while driving, because doing so can cause distraction that could lead to an accident resulting in serious personal injury or death.

Before you can use this feature, your device must be connected to a supported phone running the Tread app (*Pairing with Your Smartphone*, page 29).

When you are viewing the map, new notifications appear in a map tool at the edge of the screen. If the device is moving, you must verify you are a passenger and not the driver before you can view notifications.

- To ignore a notification, select **X**, or wait for popup to expire.
The popup closes, but the notification remains active on your phone.
- To view a notification, select the notification text.
- To listen to the notification, select **Play Message**.
The device reads the notification using text-to-speech technology. This feature is not available for all languages.

Viewing the List of Notifications

You can view a list of all active notifications.

- 1 Select  > **Smart Notifications**.

The list of notifications appears. Unread notifications appear black, and previously read notifications appear gray.

- 2 Select an option:

- To view a notification, select the notification description.
- To listen to a notification, select .

The device reads the notification using text-to-speech technology. This feature is not available for all languages.

Hands-Free Calling

NOTE: While most phones and headsets are supported and can be used, a particular phone or headset cannot be guaranteed to be compatible. All features may not be available for your phone.

Using Bluetooth wireless technology, your device can connect to your compatible mobile phone and wireless headset or helmet to become a hands-free device. To check compatibility, go to www.garmin.com/bluetooth.

Placing a Call

- 1 Select  > **Phone**.

- 2 Select an option:

- To dial a number, select **Dial**, enter the phone number, and select **Dial**.
- To view numbers of recent, missed, or recently dialed or received calls, select **Call History**, select a log, select a number, and select **Call** to dial it.
- To call a contact from your phone book, select **Phone Book**, select a contact, and select **Call**.
- To call a point of interest location such as a restaurant or attraction, select **Browse Categories**, select a category, select a location, and select **Call**.

Calling Home

Before you can call home, you must enter a phone number for your home location.

Select  > **Phone** > **Call Home**.

Placing a Call Using Voice Dial

- 1 Select  > **Phone** > **Voice Dial**.
- 2 Listen for the voice prompt.
- 3 Say **Call**, and say the contact name, phone number, or location you want to call.

Using In-Call Options



In-call options are available when you answer a call. Some options may not be compatible with your phone.

TIP: If you close the in-call options page, you can open it again by selecting  from any screen. You can also select the caller from the map.

- To set up a conference call, select **Add Call**.
- To transfer audio to your phone, select **Call in Progress on Navigator**.
TIP: You can use this feature if you want to disconnect the Bluetooth connection and remain on the call, or if you need privacy.
- To use the dial pad, select **Keypad**.
TIP: You can use this feature to use automated systems, such as voice mail.
- To mute the microphone, select **Mute**.
- To hang up, select **End Call**.

Disconnecting a Bluetooth Device

You can temporarily disconnect a Bluetooth device without deleting it from the paired devices list. The Bluetooth device can connect to your zūmo navigator automatically in the future.

- 1 Select an option:
 - To disconnect a phone, select  > **Phone**.
 - To disconnect a headset, select  > **Headset**.
- 2 Select the device to disconnect.
- 3 Select **Disconnect**.

Deleting a Paired Phone

You can delete a paired phone to prevent it from automatically connecting to your device in the future.

- 1 Select  > **Phone**.
- 2 Select the phone, and select **Forget Device**.

Traffic

NOTICE

Garmin is not responsible for the accuracy or timeliness of the traffic information.

Your device can provide information about traffic on the road ahead or on your route. You can set your device to avoid traffic when calculating routes, and to find a new route to your destination if a large traffic delay occurs on your active route ([Traffic Settings, page 48](#)). The traffic map allows you to browse the map for traffic delays in your area.

To provide traffic information, your device must be receiving traffic data.

- All product models can receive subscription-free traffic data using the Tread app.

Traffic data is not available in all areas. For information about traffic coverage areas, go to garmin.com/traffic.



Receiving Traffic Data Using Your Smartphone

Your device can receive subscription-free traffic data while connected to a smartphone running the Tread app.



- 1 Connect your device to the Tread app ([Pairing with Your Smartphone, page 29](#)).
- 2 On your zūmo device, select  > **Traffic**, and verify the **Traffic** check box is selected.

Viewing Traffic on the Map

The traffic map shows color-coded traffic flow and delays on nearby roads.

- 1 From the main menu, select  > **Traffic**.
- 2 If necessary, select  > **Legend** to view the legend for the traffic map.

Searching for Traffic Incidents

- 1 From the main menu, select  > **Traffic**.
- 2 Select  > **Incidents**.
- 3 Select an item in the list.
- 4 If there is more than one incident, use the arrows to view additional incidents.

Using the Apps

Group Ride

The Group Ride app allows you to coordinate rides and communicate with nearby riders using preset text messages, live map locations, and voice communications. You can pair your zūmo device with the Tread app on your smartphone to enable Group Ride tracking features.

Voice communication and preset messaging require a Group Ride accessory, which is not included with all product models. The voice communication feature is not available in all areas. Go to garmin.com for more information, or to purchase a Group Ride accessory.

Starting a Group Ride

You can create a group ride that allows you to choose the group radio channel, view and remove riders who join your group ride, and set the group ride name. You can create a group ride using a connected Group Ride mount, the Tread app, or both.

- 1 From the main menu, select **Group Ride**.
- 2 If necessary, enter your rider name, and select **Done**.
- 3 Select **Start a Group Ride**.
- 4 Select an option:
 - To start a group ride with riders that have a Group Ride mount, select **Create a Radio Group Ride**.
 - To start a group ride with riders using the Tread app, select **Create a Mobile Group Ride**.
- 5 If necessary, select the radio channel, and select **Next**.
- 6 Enter the ride name, and select **Done**.

As riders join your group ride, their names appear on the list.
- 7 Select **Start**.

The group ride begins after all riders sync with the group ride.

Joining a Group Ride

You can join a nearby group ride that was created by another rider.

- 1 From the main menu, select **Group Ride** > **Join a Group Ride**.
- 2 Enter the Ride ID, and select **Done**.



Rejoining a Recent Group Ride

You can rejoin any of your ten most-recent group rides.

- 1 From the main menu, select **Group Ride** > **Recent Group Rides**.
- 2 Select a recent group ride, and select **Join**.

Adding Riders to a Radio Group Ride

You can add riders to a radio group ride that is already in progress.

- 1 From the main menu, select  > **Group Ride**.
- 2 If necessary, select .
- 3 Select **Add**.
As new riders join the group ride, they appear on the list.
- 4 Select **Continue**.

Broadcasting a Message

WARNING

Do not read, send, or reply to any messages while driving. If you do so, you could become distracted by the display, which could lead to an accident causing personal injury or death.

You can broadcast a preset message to the members in your active group ride that are in range of the VHF radio.

- 1 From the main menu, select **Group Ride**.
- 2 If necessary, select .
- 3 Select **Broadcast to Group**.
- 4 Select a preset message, and select **Send**.

Broadcasting a Location

WARNING

While driving, do not interact with the display to broadcast your location. If you do so, you could become distracted by the display, which could lead to an accident causing serious personal injury or death.

You can broadcast a location to the members in your active group ride that are in range of the VHF radio.

- 1 From the main menu, select **Group Ride**.
- 2 If necessary, select .
- 3 Select **Broadcast to Group** > **Broadcast a Location**, and select a location.
- 4 Select **Share**.

Viewing a Group Ride Notification

WARNING

Do not read or reply to any notifications while driving. If you do so, you could become distracted by the display, which could lead to an accident causing serious personal injury or death.

From most pages, a notification appears when the device receives a broadcasted group ride location or message. You can also view group ride notifications in the Group Ride app.

NOTE: When you are viewing the map, new notifications appear in a map tool at the edge of the screen..

- 1 From the main menu, select **Group Ride** > , and select a notification.
- 2 Select **Go!** to navigate to a shared location.

Exiting a Group Ride

- 1 From the main menu, select **Group Ride**.
- 2 If necessary, select .
- 3 Select **Exit** > **Yes**.

Group Ride Settings

From the main menu, select **Group Ride** > .

Edit Rider Name: Allows you to set your name that displays during a group ride. This setting is not available during an active group ride.

Rider Map Labels: Sets the label displayed for each active rider on the map.

Show Tracks on Map: Shows the track that each group ride member takes on the map.

Reset Default Settings: Allows you to reset all group ride settings to default values. This setting is not available during an active group ride.

Radio



NOTE: This feature is not available on all product models.

NOTE: Before you can use the Radio app, you must install a Group Ride accessory. Go to garmin.com to purchase a Group Ride accessory.



You can use the Radio app to create radio presets, select a radio channel, and select squelch codes. To use this feature, you must connect the device and the antenna to the Group Ride mount. The zūmo device configures radio settings automatically when you join or create a group ride.

Selecting a Preset

NOTE: For some product models, the Radio app is located in the apps menu.



- 1 From the main menu, select  > **Radio**.
- 2 Select an option:
 - To move through the available presets, select  or .
 - To select a preset from the menu, select **Preset**.

Selecting a Radio Channel





- 1 From the main menu, select  > **Radio**.
- 2 Select an option:
 - To move to a different channel, select  or .
 - To select a MURS channel from the menu, select **Channel**.

Adjusting the Squelch

You can adjust the squelch and change between CTCSS, DCS, and Open squelch modes to improve audio quality and avoid radio interference in your area.



- 1 From the main menu, select  > **Radio**.
- 2 Select an option:
 - To choose a squelch code within the current mode, select  or .
 - To adjust the squelch mode, select **Open**.

Adding a Custom Radio Preset

- 1 Select  > **Radio** > **Preset** > .
- 2 Select  or  to select a channel and squelch code.
- 3 Select **Save**.

Selecting a Roger Tone

You can select the tone other devices play when you operate your radio.



- 1 Select  > **Radio** >  > **Roger Tone**.
- 2 Select a roger tone.
The device plays the selected tone.
- 3 Select **Save**.

Turning the Radio Off

Select  > **Radio** >  > **Yes**.

Enabling Push-to-Talk with a Headset

You can enable push-to-talk controls for use with a compatible Bluetooth headset. This allows you to transmit your voice using the voice dial feature on your headset.

- 1 Select  > **Radio** >  > **Push to Talk with Headset**.
- 2 If necessary, follow the on-screen instructions to pair your headset with the device.
- 3 Select **Push to Talk with Headset**.
- 4 Select .

Transmitting Your Voice

Before you can transmit your voice, you must pair your zūmo device with a compatible Bluetooth headset or connect the fist microphone.

You can transmit your voice over the radio using the connected fist microphone or a compatible Bluetooth headset.

Select an option:

- Hold the push-to-talk button on the side of the connected fist microphone.
- From the main menu, select  > **Radio** > **Push to Talk Over Headset**.
- Use the voice dial feature on your connected Bluetooth headset (*Enabling Push-to-Talk with a Headset*, page 36).



TIP: You can press the pause or stop button to manually close the radio.

NOTE: You must enable the **Push to Talk with Headset** setting to use this feature (*Radio Settings*, page 36).

Adjusting the Radio Volume

- 1 Select  > **Radio** > .
- 2 Use the slider bars to adjust the volume.

Radio Settings

From the main menu, select  > **Radio** > .



Push to Talk with Headset: Enables you to transmit your voice using the push-to-talk button on your compatible headset.

Roger Tone: Sets the roger tone the device plays when you operate your radio.

Reset Default Settings: Resets all radio settings and presets to factory default values.

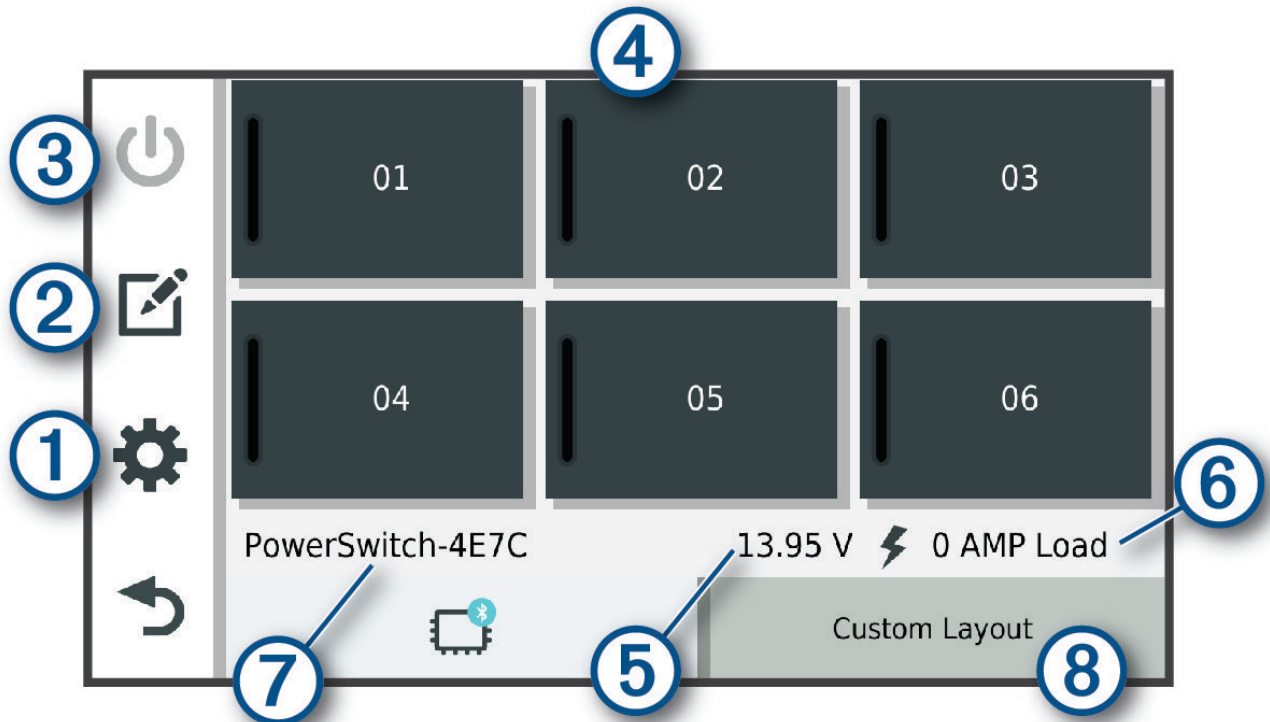
Garmin PowerSwitch™ App



| | |
|---|---|
| ①  | Opens the app settings menu |
| ②  | Enters editing mode to customize the app layout and functions |
| ③  | Turns off all outputs |
| ④ Power buttons | Activates each connected output |
| ⑤ | Displays input voltage |
| ⑥ | Displays the total amperage of the selected Garmin PowerSwitch device |
| ⑦ | Displays the device name |
| ⑧ | Displays Garmin PowerSwitch device tabs and custom layout tabs |

Activating a Power Switch



Before you can use the Garmin PowerSwitch app to activate a switch, you must install your Garmin PowerSwitch device in your vehicle and pair it with the Garmin PowerSwitch app.

From the Garmin PowerSwitch app, select a power button to turn a switch on or off.

Turning Off All Switches

Select .

Customizing a Button

- 1 From the Garmin PowerSwitch app screen, select .
The app enters editing mode.
- 2 Select  on the button you want to customize.
- 3 Select an option:
 - To change the name of the button, select the **Button Label** field, and enter a name.
 - To add an icon to the button, select the **Icon** field, and select an icon.
 - To change the button color, select a color.
 - To change the button mode, select a button mode.
 - To adjust the intensity of the switch, use the slider.
 - To set the button to activate with a control input, select a control input.
- 4 Select .
- 5 Select **Done**.

Assigning a Switch to a Control Input



Before you can use control input functions, you must connect a control input to your Garmin PowerSwitch device (*Connecting a Control Input*, page 59).

You can assign one or more switches to turn on when the Garmin PowerSwitch device receives a signal from a control input.



- 1 Select .
- 2 Select your Garmin PowerSwitch device.
- 3 Select a control input.
- 4 Select one or more switches.

Adding a Custom Layout



You can add a custom layout tab to the Garmin PowerSwitch app. Buttons added to a custom layout can control multiple switches at the same time.

- 1 From the Garmin PowerSwitch app, select .
The device enters editing mode.
- 2 Select .



Adding a Button to a Custom Layout

- 1 From the Garmin PowerSwitch app, select a custom layout tab.
- 2 Select .
The app enters editing mode.
- 3 Select **Add Button**.
- 4 On the new button, select .
- 5 Select an option:
 - To change the name of the button, select the **Button Label** field, and enter a name.
 - To add an icon to the button, select the **Icon** field, and select an icon.
 - To change the button color, select a color.
- 6 Select **Add Action**.
- 7 If necessary, select a Garmin PowerSwitch device and a switch.
- 8 Select an action:
 - To set the button to turn the switch on or off with each press, select **Toggle**.
 - To set the button to turn on the switch, select **Turn On**.
 - To set the button to turn off the switch, select **Turn Off**.
- 9 Select a button mode:
 - To set the button to activate with one touch, select **Normal**.
 - To set the button to activate only while touching the button, select **Momentary**.
 - To set the button to turn on and off repeatedly, select **Strobe**, and select time intervals.
- 10 If applicable, use the slider to set the brightness of lights.
- 11 Select .
- 12 If necessary, select **Add Action** to add additional actions for the button.
You can add one action for every switch on the Garmin PowerSwitch device.

Arranging Buttons In a Custom Layout

- 1 From the Garmin PowerSwitch app, select a custom layout tab.
- 2 Select .
The app enters editing mode.
- 3 On the button you want to move, hold  and drag the button to a new location.

Deleting a Custom Layout or Button

- 1 From the Garmin PowerSwitch app, select a custom layout tab.
- 2 Select .
The app enters editing mode.
- 3 Select an option:
 - To delete a button, select  on the button you want to delete.
 - To delete a layout tab, select  on the layout tab.



Routines

Routines automate your Garmin PowerSwitch device. When you define a routine on your compatible Garmin navigation device, it turns switches on or off automatically when the conditions of the routine are met. For example, you can set a routine to turn on a switch at specific time each day or when your vehicle reaches a specific speed. Routines are available only when using a compatible Garmin navigation device.



Adding a Routine

- 1 From the Garmin PowerSwitch app, select  > **Routines**.
- 2 If necessary, select **Add Routine**.
- 3 Select **When**.
- 4 Select a trigger:
 - To set a switch to trigger when your vehicle reaches a specific speed, select **Speed** > **Next**, and follow the on-screen instructions to enter speed thresholds.
 - To set a switch to trigger at a specific time each day, select **Time** > **Next**, and enter a time.
 - To set a switch to trigger at sunrise, select **Sunrise**.
 - To set a switch to trigger at sunset, select **Sunset**.
- 5 Select **Add Action**.
- 6 Select a device, a switch, an action, and a button mode.
- 7 If necessary, use the slider to adjust the dimmer.
- 8 Select **Save**.

Editing a Routine

- 1 From the Garmin PowerSwitch app, select  > **Routines**.
- 2 Select  on the routine you want to edit.
- 3 Select an option:
 - To change the trigger for the routine, select **When**, and select a trigger.
 - To change an action, select  on the action you want to change, and update the action.
 - To add an action to the routine, select **Add Action**, and enter information about the action.
- 4 Select **Save**.

Deleting a Routine

- 1 From the Garmin PowerSwitch app, select  > **Routines**.
- 2 Select  on the routine you want to delete.

Great Rides

WARNING

This feature allows you to follow rides and routes generated by third parties. Garmin makes no representations about the accuracy, reliability, completeness or timeliness of routes generated by third parties. Any use or reliance on such routes is at your own risk.

You can use the Great Rides feature to bookmark and navigate popular rides. You can rate rides and share photos using the Tread app on your smartphone.

Bookmarking a Ride

You can view and bookmark rides using the Tread app on your smartphone. Bookmarked rides automatically sync with your zūmo navigator while it is connected to the Tread app.

- 1 From the Tread app on your smartphone, select  > **Great Rides**.
- 2 Select an option:
 - To view a list of popular rides in your region, select **Top Rides**.
 - To view a list of nearby rides, select **Nearby**.
- 3 Select a ride.
- 4 Select **Add Bookmark**.

Synchronizing Great Rides

Bookmarked rides synchronize automatically when you open the Great Rides app on your zūmo navigator while you are connected to the Tread app on your smartphone. You can also synchronize data manually at any time.

- 1 Select  > **Great Rides**.
- 2 If necessary, select .

Navigating a Bookmarked Ride

Before you can navigate to a bookmarked ride, you must synchronize the Great Rides app on your zūmo navigator with the Tread app on your smartphone ([Synchronizing Great Rides, page 41](#)).

- 1 Select  > **Great Rides**.
- 2 Select a ride.
- 3 Select the starting point for your ride, and select **Go!**.
- 4 Select the next destination, and select **OK**.
The device calculates a route to the starting point you selected.
- 5 Select **Start**.

After you navigate a bookmarked ride, you can rate the ride and share photos using the Tread app on your smartphone.



Enabling or Disabling the Great Rides Map Layer

You can enable or disable a map layer that shows your bookmarked rides while you preview the map.

Select  > **Map Display** > **Map Layers** > **Bookmarked Great Rides**.

Viewing the Owner's Manual on Your Device

You can view the complete owner's manual on the device screen in many languages.

- 1 Select  > **Owner's Manual**.
The owner's manual appears in the same language as the software text ([System Settings, page 49](#)).
- 2 Select  to search the owner's manual (optional).

Music Player

The music player can play music or audio from these sources.

- Music files stored on your zūmo device.
- Bluetooth audio from a paired phone.

Adding the Music Player Tool to the Map

The music player map tool enables you to control the music player from your map.

- 1 Open the map.
- 2 Select  > **Music Player**.

The music player controls appear on the map.

Changing the Media Source

You can change the source from which media is played on your device.

- 1 Select **Music**.
- 2 Select the current media source ①.

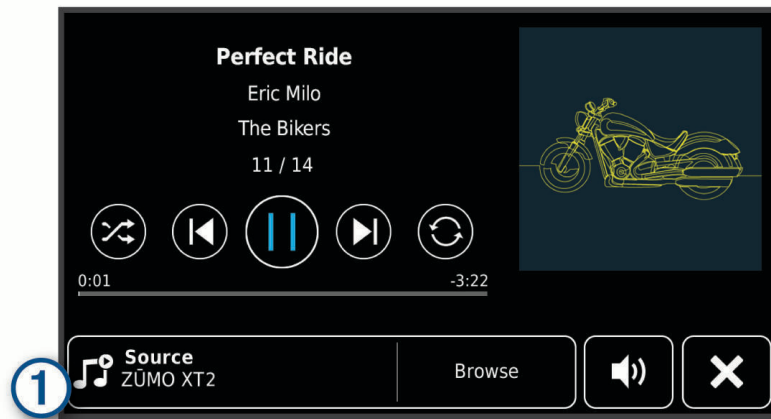



- 3 Select an available media source from the list.

BirdsEye Direct Satellite Imagery

BirdsEye direct satellite imagery provides downloadable, high-resolution map imagery, including detailed satellite imagery and raster-based topographical maps. You can download BirdsEye direct satellite imagery directly to your device while it is connected to a Wi-Fi network.

Downloading BirdsEye Direct Satellite Imagery

Before you can download BirdsEye direct satellite imagery directly to your device, you must connect to a wireless network ([Connecting to a Wi-Fi Network](#), page 51).

- 1 Select  > **BirdsEye Direct**.
- 2 Select .
- 3 Select an option:
 - To download satellite imagery files for a specific location or area, select **Location**, and select a category.
NOTE: The location defaults to your current location.
 - To select an image quality option, select **Detail**.
 - To define the size of the area to be shown in the downloaded imagery files, select **Size**, and enter a distance from the selected location.
 - To select where to save the downloaded imagery files, select **Save To**.
- 4 Select **Download**.
- 5 Enter a name for the downloaded imagery files, and select **Done**.



Route Planner

You can use the route planner to create and save a route, which you can navigate later. This can be useful for planning a delivery route, a vacation, or a road trip. You can edit a saved route to further customize it, including reordering locations, adding suggested attractions, and adding shaping points.





You can also use the route planner to edit and save your active route.

Planning a Route

A route can include many locations, and it must include at least a starting location and one destination. The starting location is the location from which you plan to start your route. If you start navigating the route from a different location, the device gives you the option to route to your starting location first. For a round trip, the starting location and final destination can be the same.



- 1 Select  > **Route Planner**.
- 2 If necessary, select a calculation mode.
NOTE: The Faster Time mode is selected by default.
- 3 Select an option to choose a location for your starting point:
 - Select a location on the map.
 - Select  and search for a location (*Finding a Location Using the Search Bar*, page 19).
- 4 Repeat step 3 to add more locations.
NOTE: The last location you add is the destination.
- 5 After you have added all the necessary locations, select .

Editing and Reordering Locations in a Route

- 1 Select  > **Routes**.
- 2 Select a saved route.
- 3 Select **List**.
- 4 Select a location.
- 5 Select an option:
 - To change the location, select , and enter a new location.
 - To move the location up or down, select , and drag the location to a new position in the route.
 - To add a new location after the selected location, select .
 - To remove the location, select .



Changing Routing Options for a Route

You can customize how the device calculates your route.

- 1 Select  > **Routes**.
- 2 Select a saved route.
- 3 Select .
- 4 Select an option:
 - To add shaping points to your route, select **Shaping**, and select at least one location.
 - To change the calculation mode for the route, touch a route segment, and select a calculation mode.

Saving Your Active Route

If a route is active, you can use the route planner to save it.

- 1 Select  > **Route Planner**.
- 2 Select  to save your route.



Navigating to a Saved Route

- 1 Select  > **Routes**.
- 2 Select a saved route.
- 3 Select **Go!**.
- 4 Select the first location to navigate to, and select **OK**.
- 5 Select **Start**.

The device calculates a route from your current location to the selected location, and then it guides you to the remaining route destinations in order.

Sharing a Route

You can share routes with other zūmo navigators.

- 1 Select  > **Explore** >  > **Share**.
- 2 Select one or more routes, and select .
- 3 Select an option:
 - To share a route using the Tread app, select **Garmin Tread**.
 - To copy the route to a microSD card, select **Memory Card**.
- 4 Select **Done**.
- 5 Follow the on-screen instructions on your zūmo navigator to complete the sharing process.

Tracks

A track is a recording of your path. The track log contains information about the recorded path, including time, location, and elevation information.

Recording Tracks

Tracking records your path. When you start tracking, your device logs your location and updates the track line. If your device is paired with a Garmin Explore account, your device periodically synchronizes recorded tracks with the app.

- 1 Select  > **Track Recorder**.
- 2 Select **Start**.

TracBack



Following Your Recent Track

The TracBack feature records the most recent segment of your movement. You can retrace your recent track back to a previous location.

- 1 Select  > **TracBack**.
Your recent track appears on the map.
- 2 Select **Go!**.

Saving Your Recent Track as a Route

You can save your recent track as a route, which you can navigate later using the route planner ([Navigating to a Saved Route](#), page 43).

- 1 Select  > **TracBack**.
Your recent track appears on the map.
- 2 Select  > **Save as Route**.
- 3 Enter a name for the route, and select **Done**.

Viewing the Weather Forecast

NOTICE

Garmin is not responsible for the accuracy or timeliness of the weather data.

Before you can use this feature, your device must be receiving weather data. You can connect your device to the Tread app to receive weather data (*Pairing with Your Smartphone, page 29*).

NOTE: Weather forecasts are not available in all areas.

- 1 Select  > **Weather**.

The device shows the current weather conditions and a forecast for the next several days.

- 2 Select a day.

The detailed forecast for that day appears.

Viewing Weather Near a Different City

- 1 Select  > **Weather** > **Current Location**.

- 2 Select an option:

- To view weather for a favorite city, select a city in the list.
- To add a favorite city, select **Add City**, and enter a city name.

Viewing the Weather Radar

Before you can use this feature, your device must be connected to a supported phone running the Tread app (*Pairing with Your Smartphone, page 29*).

- 1 Select  > **Weather Radar**.

- 2 Select  to animate the radar map.

Viewing Weather Alerts

Before you can use this feature, your device must be connected to a supported phone running the Tread app (*Pairing with Your Smartphone, page 29*).

NOTE: This feature is not available in all areas.

While you are traveling with your device, weather alerts may appear on the map. You can also view a map of weather alerts near your current location or near a selected city.

- 1 Select  > **Weather**.

- 2 If necessary, select a city.

- 3 Select  > **Weather Alerts**.

Checking Road Conditions

Before you can use this feature, your device must be connected to a supported phone running the Tread app (*Pairing with Your Smartphone, page 29*).

You can view weather-related road conditions for the roads in your area, on your route, or in another city.





- 1 Select  > **Weather**.

- 2 If necessary, select a city.

- 3 Select  > **Road Conditions**.

Creating a Round-Trip Route

The device can create a round-trip route using a specified starting location and a distance, duration, or destination.

- 1 From the main menu, select  > **Round Trip**.
- 2 Select **Start Location**.
- 3 Select a location, and select **Select**.
- 4 Select **Trip Attributes**.
- 5 Select an option:
 - Select **Choose a Distance** to plan your route by distance.
 - Select **Choose a Duration** to plan your route based on time.
 - Select **Choose a Destination** to plan your route based on a specified location.
- 6 Select **Next**.
- 7 Enter a distance, duration, or destination.
- 8 Select an option:
 - If you entered a distance or duration, select **Done**.
 - If you selected a destination, select **Select**.
- 9 Select **Add a Direction**.
- 10 Select a direction, and select **Next**.
- 11 Select **Calculate**.
- 12 Select one or more options:
 - Select  to view elevation statistics along your route.
 - Select  to shape your route.
 - Use the slider to increase or decrease the level of adventure on your route.
 - Select , and select one or more route features.
- 13 Select a route, and select **Go!**.

Viewing Previous Routes and Destinations

Before you can use this feature, you must enable the travel history feature (*Device and Privacy Settings*, page 49).

You can view your previous routes and places you have stopped on the map.

Select  > **Where I've Been**.

Settings

Bluetooth Settings

Phone Settings

Select  > **Phone**, and select your phone.

Disconnect: Disconnects the paired phone.

Phone Name: Displays the name of the paired phone. You can select the name to change how it displays on your navigation device.

Media Audio: Enables the navigation device to play media audio from your paired phone.

Garmin Tread: Appears when the navigation device is connected to the Tread app on your phone.

Forget Device: Removes the connected device from the list of paired devices. This option is available only after a device is paired.

Headset Settings

Select  > **Headset**, and select your headset.

Disconnect: Disconnects the paired headset.

Headset Name: Displays the name of the paired headset. You can select the name to change how it appears on your navigation device.

Navigation Audio Quality: Sets the audio quality for navigation prompts.

Headset: Enables or disables headset features.

Media Audio: Enables or disables media audio through the headset.

Forget Device: Removes the headset from the list of paired devices.

Wi-Fi Settings

The wireless network settings allow you to manage Wi-Fi networks.

Select  > **Wi-Fi**.

Wi-Fi: Enables the Wi-Fi radio.

Saved Networks: Allows you to edit or remove saved networks.

Search for Networks: Searches for nearby Wi-Fi networks (*Connecting to a Wi-Fi Network, page 51*).

Map Display Settings

Select  > **Map Display**.

Map Vehicle Icon: Sets the vehicle icon that represents your position on the map.

Driving Map View: Sets the perspective on the map.

Map Detail: Sets the level of detail on the map. More detail may cause the map to draw slower.

Map Theme: Changes the color of the map data.

Map Layers: Sets the data that appears on the map page (*Customizing the Map Layers, page 28*).

Waypoint Decluttering: Hides waypoints at high map zoom levels.

Auto Zoom: Automatically selects the zoom level for optimal use of your map. When disabled, you must zoom in or out manually.

Skip Next Stop Confirmation: Sets a confirmation message to appear when skipping a location on your route.

myMaps: Sets which installed maps the device uses.

Enabling Maps

You can enable map products installed on your device.

TIP: To purchase additional map products, go to garmin.com/maps.

1 Select  > **Map Display** > **myMaps**.

2 Select a map.

Navigation Settings

Select  > **Navigation**.

Calculation Mode: Sets the route calculation method.

Off-Route Recalculation: Sets recalculation preferences when navigating away from an active route.

Avoidances: Sets road features to avoid on a route.

Custom Avoidances: Allows you to avoid specific roads or areas.

Traffic: Sets options for traffic features.

Environmental Zones: Sets the avoidance preferences for areas with environmental or emissions restrictions that may apply to your vehicle.

Restricted Mode: Disables all functions that require significant operator attention.

GPS Simulator: Stops the device from receiving a GPS signal, and saves battery power.

Traffic Settings

From the main menu, select  > **Navigation** > **Traffic**.

Traffic: Enables traffic.

Optimize Route: Enables the device to use optimized alternate routes automatically or upon request (*Avoiding Traffic Delays on Your Route*, page 16).

Current Provider: Sets the traffic provider to use for traffic data. The Auto option selects the best available traffic data automatically.

Subscriptions: Lists the current traffic subscriptions.

Setting a Simulated Location

If you are indoors or not receiving satellite signals, you can use the GPS simulator to plan routes from a simulated location.

1 Select  > **Navigation** > **GPS Simulator**.

2 From the main menu, select **View Map**.

3 Tap the map twice to select an area.

The address of the location appears at the bottom of the screen.

4 Select the location description.

5 Select **Set Location**.

Driver Assistance Settings

Select  > **Driver Assistance**.

Rider Alerts: Allows you to enable or disable alerts for upcoming zones or road conditions (*Rider Awareness Features and Alerts*, page 7).

Speeding Alert: Alerts you when you are exceeding the speed limit.

Reduced Speed Tone: Alerts you when the speed limit decreases.

Ride Summary: Displays a summary of your ride at the end of a route.

Helmet Guide: Displays changes for helmet requirements when crossing borders.

Country Border Alert: Displays a notification when crossing international borders.

Route Preview: Displays a preview of the major roads in your route when you start navigation.

Break Planning: Reminds you to take a break, and displays upcoming services after you drive for an extended time. You can enable or disable break reminders and upcoming service suggestions.

Automatic Incident Detection: Enables the navigator to detect incidents and to notify emergency contacts when the navigator detects an incident (*Incident Detection and Notifications*, page 8).

Incident Messaging: Alerts your emergency contacts if an incident is detected (*Incident Detection and Notifications*, page 8).

Proximity Alerts: Alerts you when you approach speed cameras or red light cameras.

Display Settings

Select  > **Display**.

Orientation: Allows you to set the display to portrait (vertical) or landscape (horizontal).

NOTE: This feature is not available on all product models.

Color Mode: Allows you to select day or night color mode. If you select the Auto option, the device automatically switches to day or night colors based on the time of day.

Brightness: Allows you to adjust the display brightness.

Display Timeout: Allows you to set the amount of idle time before your device enters sleep mode while using battery power.

Screenshot: Allows you to take a picture of the device screen. Screenshots are saved in the Screenshot folder of the device storage.

System Settings

Select  > **System**.

Voice Language: Sets the language for voice prompts.

Text Language: Sets all on-screen text to the selected language.

NOTE: Changing the text language does not change the language of user-entered data or map data, such as street names.

Keyboard Language: Enables keyboard languages.

Units: Sets the unit of measure used for distances.

Current Time: Sets the device time.

Time Format: Allows you to select a 12-hour, 24-hour, or UTC display time.

Position Format: Sets the coordinate format and datum used for geographical coordinates.

Setting the Time

- 1 From the main menu, select the time.
- 2 Select an option:
 - To set the time automatically using GPS information, select **Automatic**.
 - To set the time manually, drag the numbers up or down.

Device and Privacy Settings

Select  > **Device**.

About: Displays the software version number, the unit ID number, and information on several other software features.

Regulatory: Displays regulatory markings and information.

EULAs: Displays the end-user license agreements.

NOTE: You need this information when you update the system software or purchase additional map data.

Software Licenses: Displays software licensing information.



Device Data Reporting: Shares anonymous data to improve the device.

Travel History: Allows the device to store a record of the places you go. This allows you to view the trip log, use the Where I've been feature, and use myTrends™ suggested routes.

Reset: Allows you to clear your travel history, reset settings, or delete all user data.

Restoring Settings

You can restore a category of settings or all settings to the factory default values.

- 1 Select .
- 2 If necessary, select a settings category.
- 3 Select  > **Restore**.

Device Information

Viewing E-label Regulatory and Compliance Information

- 1 From the settings menu, swipe to the bottom of the menu.
- 2 Select **Device > Regulatory**.

Specifications

| | |
|--|--|
| Water resistance | IEC 60529 IPX7 ¹ |
| Operating temperature range | From -15° to 55°C (from 5° to 131°F) |
| Charging temperature range | From 0° to 45°C (from 32° to 113°F) |
| Power input (vehicle power cable, motorcycle, or external power) | From 12 to 24 Vdc |
| Battery type | Lithium-ion battery |
| Battery voltage range | From 3.5 to 4.1 V |
| Wireless frequencies and transmit power | 2.4 GHz @ 17.6 dBm maximum 5.1 GHz @ 17.4 dBm maximum 5.2 GHz @ 21.3 dBm maximum |
| EU SAR | 0.1 W/kg torso, 0.17 W/kg limb |

Charging the Device

NOTE: This Class III product shall be powered by an LPS power supply.

You can charge the battery in the device using any of these methods.

- Install the device in the mount, and connect the mount to vehicle power.

NOTICE

Do not connect the device directly to the vehicle power cable.

- Connect the device to an optional power adapter accessory, such as a wall power adapter. You can purchase an approved Garmin AC-DC adapter suitable for home or office use from a Garmin dealer or www.garmin.com. The device may charge slowly when connected to a third-party adapter.

Device Maintenance

Garmin Support Center

Go to support.garmin.com for help and information, such as product manuals, frequently asked questions, videos, and customer support.

Map and Software Updates

For the best navigation experience, you should keep the maps and software on your device up to date.

Map updates provide the newest available changes to roads and locations in the maps used by your device. Keeping maps up to date helps your device find recently added locations and calculate more accurate routes. Map updates are large and may take several hours to complete.

Software updates provide changes and improvements to the device features and operation. Software updates are small and take a few minutes to complete.

You can update your device using two methods.

- You can connect the device to a Wi-Fi network to update directly on the device (recommended). This option allows you to update your device conveniently without connecting it to a computer.
- You can connect the device to a computer and update it using the Garmin Express application (garmin.com/express).

¹*The device withstands incidental exposure to water of up to 1 m for up to 30 min. For more information, go to www.garmin.com/waterrating.

Connecting to a Wi-Fi Network

The first time you turn on the device, it prompts you to connect to a Wi-Fi network and register your device. You can also connect to a Wi-Fi network using the settings menu.

- 1 Select  > **Wi-Fi**.
- 2 If necessary, select **Wi-Fi** to enable Wi-Fi technology.
- 3 Select **Search for Networks**.
The device displays a list of nearby Wi-Fi networks.
- 4 Select a network.
- 5 If necessary, enter the password for the network, and select **Done**.



The device connects to the network, and the network is added to the list of saved networks. The device reconnects to this network automatically when it is within range.

Updating Maps and Software Using a Wi-Fi Network

NOTICE

Map and software updates may require the device to download large files. Regular data limits or charges from your internet service provider apply. Contact your internet service provider for more information about data limits or charges.

You can update the maps and software by connecting your device to a Wi-Fi network that provides access to the internet. This allows you to keep your device up to date without connecting it to a computer.

- 1 Connect the device to a Wi-Fi network (*Connecting to a Wi-Fi Network, page 51*).
While connected to a Wi-Fi network, the device checks for available updates. When an update is available,  appears on the  icon in the main menu.
- 2 Select  > **Updates**.
The device checks for available updates. When an update is available, **Update Available** appears below Map or Software.
- 3 Select an option:
 - To install all available updates, select **Install All**.
 - To install only map updates, select **Map > Install All**.
 - To install only software updates, select **Software > Install All**.
- 4 Read the license agreements, and select **Accept All** to accept the agreements.
NOTE: If you do not agree with the license terms, you can select **Reject**. This stops the update process. You cannot install updates until you accept the license agreements.
- 5 Using the included USB cable, connect the device to external power, and select **Continue** (*Charging the Device, page 50*).
For the best results, a USB wall charger that provides at least 2 A power output is recommended. Many USB power adapters for smartphones, tablets, or portable media devices may be compatible.
- 6 Keep the device connected to external power and within range of the Wi-Fi network until the update process is complete.

TIP: If a map update is interrupted or canceled before it completes, your device may be missing map data. To repair missing map data, you must update the maps again using either Wi-Fi or Garmin Express.

Product Updates

On your computer, install Garmin Express (www.garmin.com/express).

This provides easy access to these services for Garmin devices:

- Software updates
- Map updates
- Product registration

Updating Maps and Software with Garmin Express

You can use the Garmin Express application to download and install the latest map and software updates for your device.

1 If you do not have the Garmin Express application installed on your computer, go to garmin.com/express and follow the on-screen instructions to install it.

2 Open the  Garmin Express application.

3 Connect your device to your computer using a USB cable.

The small end of the cable connects to the USB port ① on your zūmo device, and the large end connects to an available USB port on your computer.

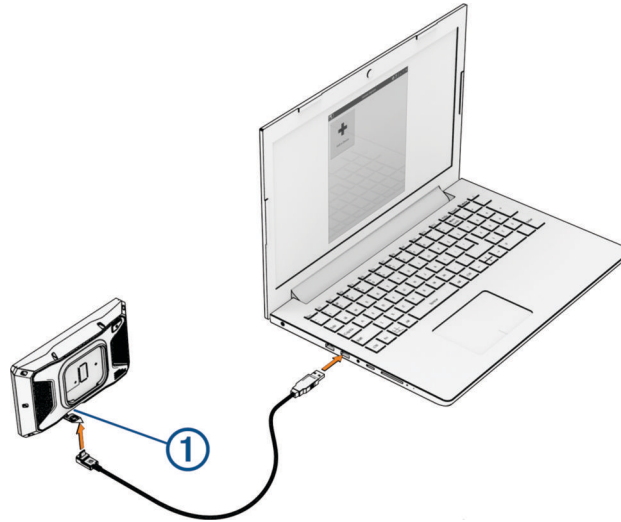

4 From your zūmo device, select **Tap to Connect to Computer**.

5 In the Garmin Express application, click **Add a Device**.

The Garmin Express application searches for your device and displays the device name and serial number.

6 Click **Add Device**, and follow the on-screen instructions to add your device to the Garmin Express application.

When setup is complete, the Garmin Express application displays the updates available for your device.

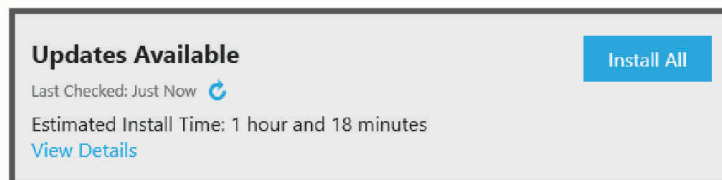

7 Select an option:

- To install all available updates, click **Install All**.
- To install a specific update, click **View Details**, and click **Install** next to the update you want.

The Garmin Express application downloads and installs the updates onto your device. Map updates are very large, and this process may take a long time on slower internet connections.

NOTE: If a map update is too large for the internal storage of the device, the software may prompt you to install a microSD card in your device to add storage space (*Installing a Memory Card for Maps and Data*, page 63).

8 Follow the on-screen instructions during the update process to finish installing updates.

For example, during the update process, the Garmin Express application may instruct you to disconnect and reconnect your device.

Device Care

NOTICE

Avoid dropping your device.

Do not store the device where prolonged exposure to extreme temperatures can occur, because it can cause permanent damage.

Never use a hard or sharp object to operate the touchscreen, or damage may result.

Cleaning the Outer Casing

NOTICE

Avoid chemical cleaners and solvents that can damage plastic components.

- 1 Clean the outer casing of the device (not the touchscreen) using a cloth dampened with a mild detergent solution.
- 2 Wipe the device dry.

Cleaning the Touchscreen

- 1 Use a soft, clean, lint-free cloth.
- 2 If necessary, lightly dampen the cloth with water.
- 3 If using a dampened cloth, turn off the device and disconnect the device from power.
- 4 Gently wipe the screen with the cloth.

Restarting the Device

You can restart your device if it stops functioning.

Hold the power button for 12 seconds.

Removing the Device, Mount, and Suction Cup

Removing the Device from the Mount

- 1 Press the release tab or button on the mount.
- 2 Tilt the top of the device downward, and lift the device from the mount.

Removing the Mount from the Suction Cup

- 1 Turn the device mount to the right or left.
- 2 Apply pressure until the socket on the mount releases the ball on the suction cup.

Removing the Suction Cup from the Windshield

- 1 Flip the lever on the suction cup toward you.
- 2 Pull the tab on the suction cup toward you.

Changing the Fuse in the Fuse Cable

NOTICE

When replacing the fuse, verify the replacement fuse is fully inserted into the fuse housing. The vehicle power cable does not work unless it is assembled correctly.

If your device does not charge in your vehicle, you may need to replace the fuse located on the red system power cable.

- 1 Lift up the cover from the top of the fuse housing.
- 2 Insert a new 3 A fuse.
- 3 Replace the cover on the fuse housing.

Troubleshooting

My device is not acquiring satellite signals

- Verify the GPS simulator is turned off (*Navigation Settings, page 47*).
- Take your device out of parking garages and away from tall buildings and trees.
- Remain stationary for several minutes.

My battery does not stay charged for very long

- Decrease the screen brightness (*Display Settings, page 48*).
- Shorten the display timeout (*Display Settings, page 48*).
- Decrease the volume (*Adjusting the Volume, page 3*).
- Turn off the wi-fi radio when it is not in use (*Wi-Fi Settings, page 47*).
- Put the device in power saving mode when not in use (*Turning the Device On or Off, page 1*).
- Keep your device away from extreme temperatures.
- Do not leave your device in direct sunlight.

My device is not contacting my emergency contact

WARNING

The device allows you to send your location to an emergency contact. This is a supplemental feature and should not be relied upon as a primary method to obtain emergency assistance. The Tread app does not contact emergency services on your behalf.

If your device is not contacting your emergency contact, you can try these options.

- Verify the zūmo navigator is connected to a compatible external power source, such as the included mount or using a USB cable (*Installation, page 4*).
- Verify the zūmo navigator is connected to the Tread app on your smartphone using Bluetooth wireless technology (*Pairing with Your Smartphone, page 29*).
- Verify your smartphone is in an area of network coverage where data connectivity is available.
- Verify that the **Automatic Incident Detection** feature and the **Incident Messaging** feature are enabled on your zūmo navigator (*Driver Assistance Settings, page 48*).
- Verify that you have set up an emergency contact using the Tread app on your smartphone (*Setting Up an Emergency Contact, page 9*).
- Verify the incident contact's phone is capable of receiving text messages or email.

My device does not connect to my phone

- Select  > **Phone**, and verify that your phone is paired with the navigator.
- Enable Bluetooth wireless technology on your phone, and bring your phone within 10 m (33 ft.) of the device.
- Verify your phone is compatible.
Go to www.garmin.com/bluetooth for more information.
- Complete the pairing process again.
To repeat the pairing process, you must unpair your phone and device (*Disconnecting a Bluetooth Device, page 32*), and complete the pairing process (*Pairing with Your Smartphone, page 29*).

The suction cup will not stay on my windshield

- 1 Clean the suction cup and windshield with rubbing alcohol.
- 2 Dry with a clean, dry cloth.
- 3 Mount the suction cup (*Mounting Your Device in an Automobile, page 55*).

My device does not appear as either a portable device or a removable drive or volume on my computer

- 1 Disconnect the USB cable from your computer.
- 2 Turn off the device.
- 3 Connect the USB cable to your device and to a USB port on your computer.

TIP: The USB cable must connect to a USB port on your computer, not to a USB hub.

The device turns on automatically and goes into MTP mode or USB mass storage mode. A picture of the device connected to a computer appears on the device screen.

NOTE: If you have several network drives mapped on your computer, Windows® may have trouble assigning drive letters to your Garmin drives. For information about assigning drive letters, see the help file for your operating system.

Appendix

Mounting Your Device in an Automobile

⚠ WARNING

See the *Important Safety and Product Information* guide in the product box for product warnings and other important information.

This product contains a lithium-ion battery. To prevent the possibility of personal injury or product damage caused by battery exposure to extreme heat, store the device out of direct sunlight.

Do not use the suction cup mount on a motorcycle.

NOTICE

Before mounting the device, check the local laws pertaining to windshield mounting.

NOTE: The automobile mount is an optional accessory. Go to garmin.com to purchase optional accessories.

- 1 Plug the automotive power cable ① into the port ② on the device.

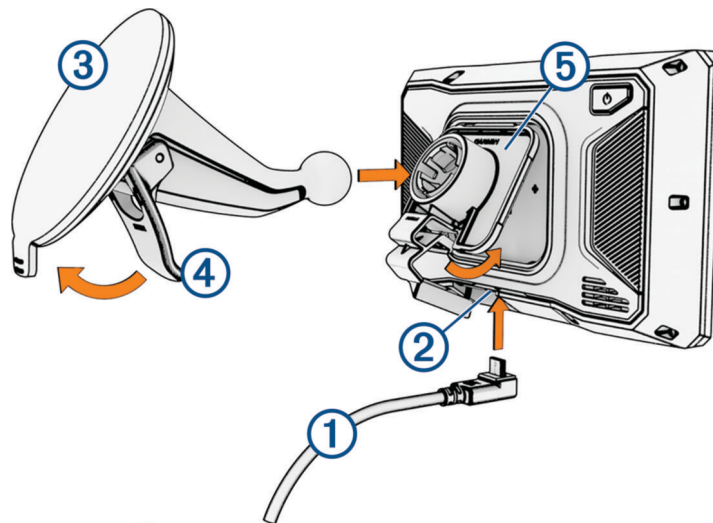

- 2 Remove the clear plastic from the suction cup ③.
- 3 Clean and dry your windshield and the suction cup with a lint-free cloth.
- 4 Press the suction cup to the windshield, and flip the lever ④ back toward the windshield.
- 5 Snap the cradle ⑤ onto the suction cup arm.
- 6 Fit the top of your device into the cradle.
- 7 Press the device into the cradle until it snaps into place.
- 8 Plug the other end of the automotive power cable into a power outlet.

Garmin PowerSwitch

⚠ WARNING

Garmin strongly recommends having an experienced installer with the proper knowledge of electrical systems install the device. Incorrectly wiring the power cable can result in damage to the vehicle or the battery and can cause bodily injury.

You can use a connected Garmin PowerSwitch device to control lights, fans, and more from your zūmo device.

Mounting Considerations

- The device must be mounted close to the battery and within the range of the supplied power cable.
- The mounting surface must be strong enough to support the weight of the device.
- The location must allow room for the routing and connection of all cables.

Mounting the Device

Before you can mount the device, you must select a mounting location and purchase the appropriate hardware for your mounting surface.

NOTICE

Avoid wires, gauges, air bags, air bag covers, HVAC, and other items when drilling pilot holes and attaching the mount to the vehicle. Garmin is not responsible for any damages or consequences arising from the installation.

- 1 Place the mount on the selected location.



- 2 Using the mount as a template, mark the two screw locations ①.
- 3 Drill pilot holes (optional).
For some types of mounting material, drilling pilot holes is necessary. Do not drill through the mount.
- 4 Securely fasten the mount to the surface using the appropriate hardware for your mounting surface.

Opening the Front Cover

You must open the front cover to make electrical connections.

- 1 Lift the front cover latch ① and rotate it counter-clockwise.



- 2 Pull the front cover off of the device.



Connecting Accessories

NOTICE

Do not use the device to control or power a winch. Failure to follow this notice could cause damage to your vehicle or your device.

Do not connect a power source to an accessory output terminal. Failure to follow this notice could cause damage to your vehicle or your device.

Accessory requirements:

- Verify the amperage rating of each accessory before wiring it to the Garmin PowerSwitch device. The device supports accessories up to 30 A for each channel and a maximum of 100 A for the entire system.
- Use 10 AWG (6 mm²) wires for accessories that use 20 to 30 A.
- Use 12 AWG (4 mm²) wires for accessories that use 10 to 20 A.
- Use 14 AWG (2.5 mm²) wires for accessories that use less than 10 A.
- Use the appropriate size terminals for all accessory connections.
- Crimp all terminal connectors securely.

- 1 Connect the positive wire from the accessory ① to one of the accessory terminals ② on the Garmin PowerSwitch device.

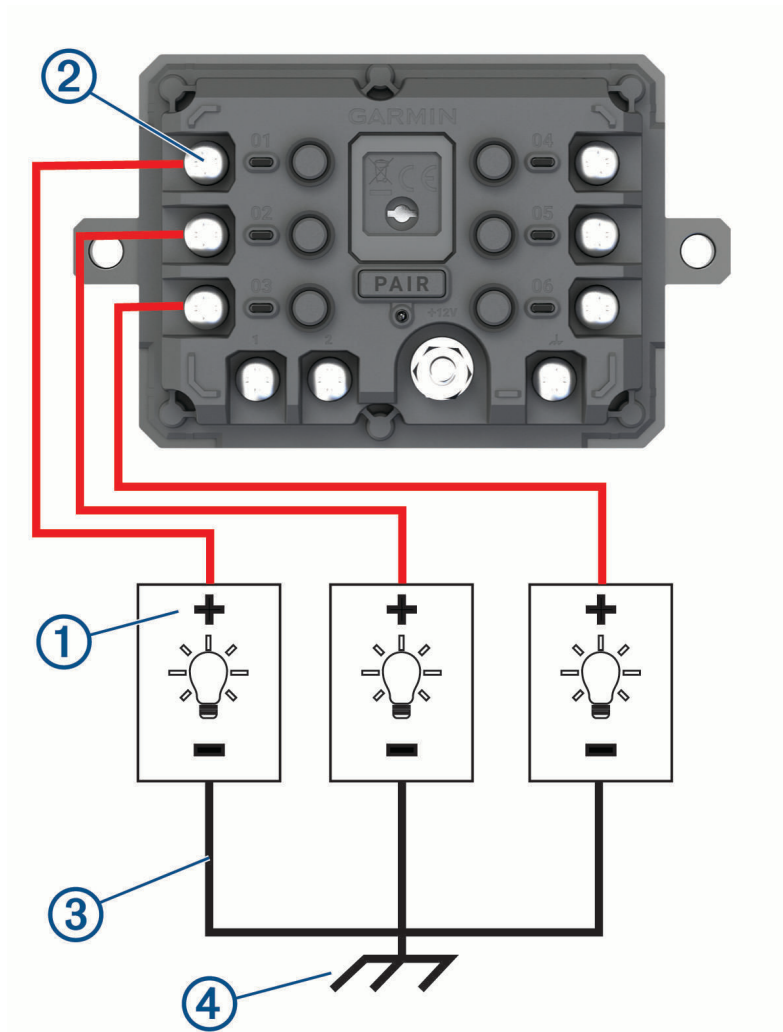

- 2 Connect the negative or ground wire ③ to an unpainted ground stud ④ on the vehicle frame, to a ground distribution block, or directly to the negative terminal on the battery.

⚠ CAUTION

Do not connect the accessory ground wires to the ground terminal (GND) on the Garmin PowerSwitch device, as doing so could result in personal injury or property damage, or could negatively impact device functionality.

3 Verify that all electrical connections are tight and will not come loose during use.

Connecting a Control Input

You can connect to the control terminals to enable the Garmin PowerSwitch device to turn on customizable outputs. For example, you can connect your vehicle ignition switch to a control input terminal to turn on accessories automatically each time you start your vehicle. The control terminals detect a signal from 3.3 V to 18 V. You can configure output functions with the Garmin PowerSwitch app.

Connect the control wire from the control source in your vehicle to one of the two control terminals on the Garmin PowerSwitch device.

Connecting the Device to Vehicle Power

Before you can connect the device to vehicle power, you must remove the warning tag from the +12V terminal on the device.

You should always confirm all electrical connections are secure and will not come loose while operating the device.

1 Connect the large ring end of the included ground wire ① to the negative terminal on the vehicle battery.

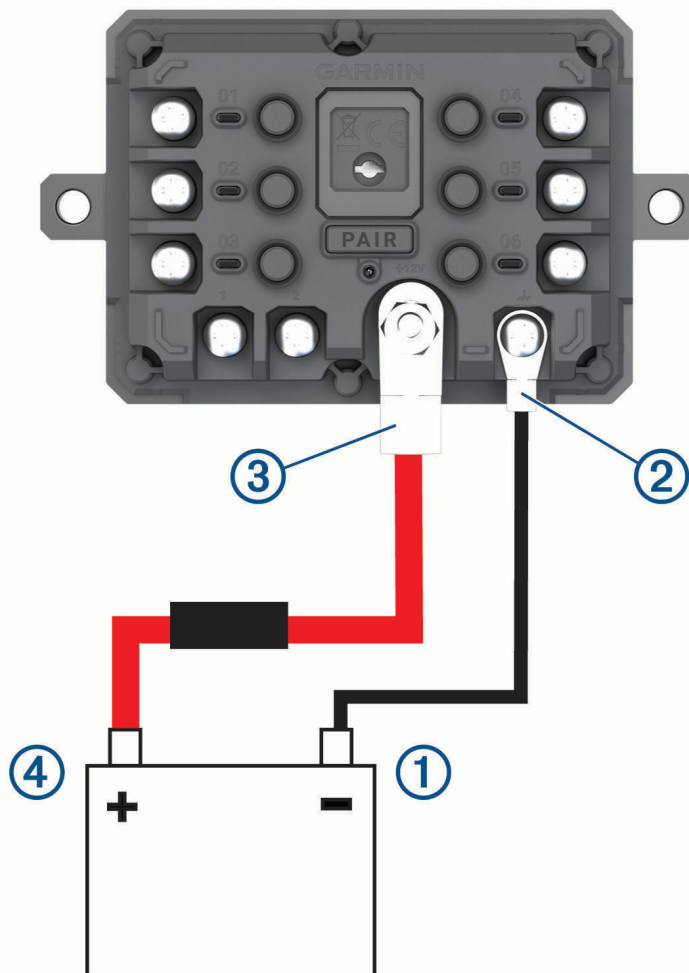

2 Connect the small ring end of the ground wire to the **GND** terminal ② on the device.

3 Connect the small ring end of the included 12V cable to the **+12V** terminal ③ on the device.

- 4 Tighten the $\frac{3}{8}$ in. nut on the +12V terminal to a maximum torque specification of 4.52 N-m (40 lbf-in.). You should confirm the nut cannot be loosened by hand.

NOTICE

Do not overtighten the +12V terminal to prevent damage to the terminal.

- 5 Connect the large ring end of the 12V cable ④ to the positive terminal on the vehicle battery.

Pairing with a Garmin Navigation Device

You can pair your Garmin PowerSwitch device with a compatible Garmin navigation device.

- 1 Turn on power to your Garmin PowerSwitch device, and place your compatible Garmin navigation device within 1 m (3.3 ft.) of it.
- 2 On your compatible navigation device, open the Garmin PowerSwitch app.
- 3 Follow the on-screen instructions to complete the pairing and setup process.

The main app dashboard appears. After the devices are paired, they connect automatically when they are turned on and within range.

Garmin PowerSwitch Specifications

| | |
|-----------------------------------|---|
| Dimensions (D x W x H) | 75 x 125 x 32 mm (2.95 x 4.92 x 1.26 in.) |
| Operating temperature range | From -25° to 85°C (from -13° to 185°F) |
| Wireless frequency | 2.4 GHz @ 10 dBm |
| Power input | From 12 to 16 V using the included vehicle power cable. |
| Maximum accessory output | 30 A |
| Maximum system output | 100 A |
| Current draw with all outputs off | 3 mA |
| Water rating | IEC 60529 IPX7 ² |

My Garmin PowerSwitch will not stay connected

- Verify the Garmin PowerSwitch device is receiving power.
- Verify that Bluetooth technology is enabled on your paired navigation device or smartphone.
- Move the navigation device or smartphone closer to your Garmin PowerSwitch device.
- Verify that your vehicle's battery is supplying at least 12 V of power.

The Garmin PowerSwitch device turns off all outputs automatically to preserve your vehicle's battery if it is receiving less than 11 V of power (*My accessories are not receiving power, page 61*).

²*The device withstands incidental exposure to water of up to 1 m for up to 30 min. For more information, go to www.garmin.com/waterrating.

My accessories are not receiving power

- Verify the Garmin PowerSwitch device is receiving power from the vehicle battery.
- Verify that your vehicle's battery is supplying at least 12 V of power.
The Garmin PowerSwitch device turns off all outputs automatically to preserve your vehicle's battery if it is receiving less than 11 V of power. Outputs turn back on when the device detects more than 12 V of power.
- Verify that all electrical connections are secure and will not come loose while operating the vehicle.
- Verify that each connected accessory draws less than 30 A.
If an accessory draws more than 30 A, the device turns off that output automatically.
- Verify that the total system load is less than 100 A.
If the device detects a system load of more than 100 A, it turns off all outputs automatically.
- Inspect all electrical connections for an electrical short circuit.

Wireless Cameras

Your device can display the video feed from one or more connected wireless cameras (sold separately).

Pairing the Camera with a Garmin Navigation Device

You can pair the camera with a compatible Garmin navigation device. For more information about compatible Garmin devices, go to the product page at garmin.com/bc40.

- 1 Update your navigation device to the latest software.
Your device may not support the BC 40 camera without the latest software. For more information about updating the software, see the owner's manual for your navigation device.
- 2 Install batteries in the camera.
The camera enters pairing mode automatically, and the LED flashes blue while the camera is in pairing mode. The camera remains in pairing mode for two minutes. If pairing mode expires, you can remove and reinstall the batteries.
- 3 Bring the compatible Garmin navigation device outside your vehicle and within 1.5 m (5 ft.) of the camera, and turn on the navigation device.
The device detects your camera automatically and prompts you to pair with it.
- 4 Select **Yes**.
TIP: If the navigation device does not detect the camera automatically, you can select  > **Wireless Cameras** > **Add New Camera** to pair with it manually.
The device pairs with your camera.
- 5 Enter a name for the camera (optional).
You should use a descriptive name that clearly identifies the location of the camera.
- 6 Select **Done**.

Pairing a BC™ 50 Camera with a Garmin Navigation Device

You can pair the BC 50 camera with a compatible Garmin navigation device. Go to garmin.com/bc50 for more information about device compatibility.

- 1 Update your navigation device to the latest software.
Your device may not support the BC 50 camera without the latest software. For more information about updating the device software, see the owner's manual for your navigation device.
- 2 Select  > **Wireless Camera** > **Add New Camera**.
- 3 Follow the on-screen instructions to finish pairing and setting up the camera.

After you complete the pairing process with a camera for the first time, it connects automatically to the Garmin navigation device when power is applied.

Viewing the Wireless Camera

⚠ WARNING

This device is intended to enhance situational awareness when used properly. If used improperly, you could become distracted by the display, which could lead to an accident causing serious personal injury or death. Always view the display at a glance when the vehicle is in motion to avoid becoming distracted.



Select  > **Wireless Cameras**.

Aligning the Guidance Lines

For the best reference points, the guidance lines should be aligned to reflect the outside edges of the vehicle. You should align the guidance lines separately for each backup camera. On some models, adjustment is automatically available after pairing a camera.

⚠ WARNING

You must ensure that the guidance lines are properly aligned before using the device and after making any camera angle adjustments. Failure to properly align the guidance lines could result in an accident or collision, resulting in death, serious injury, or property damage.

- 1 Position the vehicle with one side closely aligned to a curb, driveway, or parking stall lines.
You may want to position the vehicle in the center of a parking stall, and then pull forward into the next stall. This allows you to use the parking stall lines in the rear of the vehicle as reference points for alignment. The curb, driveway, or parking stall lines should be clearly visible on the device.
- 2 Select an option:
 - From the camera view, tap the screen, and select .
 - From the camera view, select  > **Adjust Video**.
- 3 Drag the circles on the corners of the guidance lines , or tap the arrows until they match the angle and position of the curb, driveway, or parking stall lines.
The guidance lines should appear directly on top of your reference points.
The red or orange section of the guidance lines should align with the rear of your vehicle.

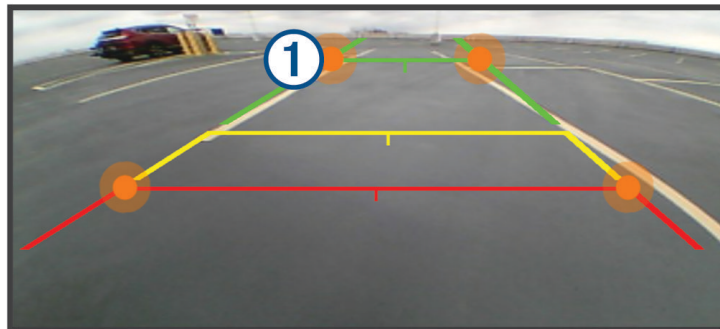

- 4 If necessary, reposition the vehicle with the other side closely aligned to a curb, driveway, or parking stall lines, and repeat the alignment process.
You should attempt to keep the guidance lines symmetrical, even if your vehicle is not in perfect alignment with the curb, driveway, or parking stall lines.
- 5 Select  after alignment is complete.

Installing a Memory Card for Maps and Data

You can install a memory card to increase the storage space for maps and other data on your device. You can purchase memory cards from an electronics supplier. The device supports microSD memory cards from 4 to 256 GB. Memory cards must use the FAT32 file system format.

- 1 Locate the map and data memory card slot on your device (*Device Overview, page 1*).
- 2 Insert a memory card into the slot.
- 3 Press it in until it clicks.

Data Management

The device has a memory card slot for additional data storage.

NOTE: The device is compatible with Windows 7 and newer, and Mac® OS 10.7 and newer.

About Memory Cards

You can purchase memory cards from an electronics supplier, or purchase pre-loaded Garmin mapping software (www.garmin.com). Memory cards can be used to store files such as maps and POIs.

Connecting the Device to Your Computer

You can connect the device to your computer using a USB cable.

- 1 Plug the small end of the USB cable into the port on the device.
- 2 Plug the larger end of the USB cable into a port on your computer.
- 3 From your zūmo device, select **Tap to Connect to Computer**.

A picture of your device connected to a computer appears on the device screen.

Depending on your computer operating system, the device appears as either a portable device, a removable drive, or a removable volume.

Transferring GPX Files From Your Computer

Apple® computers may require additional third-party software, such as Android File Transfer, to read and write files on this device.

If you have already created routes that you want to use on your device, you can transfer GPX files directly from your computer.

- 1 Connect the device to your computer (*Connecting the Device to Your Computer, page 63*).
The device appears as a portable device.
- 2 On your computer, open the file browser.
- 3 Select a GPX file.
- 4 Select **Edit > Copy**.
- 5 Browse to the GPX folder on the device.
- 6 Select **Edit > Paste**.

Transferring Data From Your Computer

- 1 Connect the device to your computer (*Connecting the Device to Your Computer, page 63*).
Depending on your computer operating system, the device appears as either a portable device, a removable drive, or a removable volume.
- 2 On your computer, open the file browser.
- 3 Select a file.
- 4 Select **Edit > Copy**.
- 5 Browse to a folder on the device.
NOTE: For a removable drive or volume, you should not place files in the Garmin folder.
- 6 Select **Edit > Paste**.

Disconnecting the USB Cable

If your device is connected to your computer as a removable drive or volume, you must safely disconnect your device from your computer to avoid data loss. If your device is connected to your Windows computer as a portable device, it is not necessary to safely disconnect the device.

- 1 Complete an action:
 - For Windows computers, select the **Safely Remove Hardware** icon in the system tray, and select your device.
 - For Apple computers, select the device, and select **File > Eject**.
- 2 Disconnect the cable from your computer.

Adding BaseCamp™ Data to Garmin Explore

You can export your BaseCamp data files and import them to Garmin Explore for use with your zūmo device.

- 1 Export your data from BaseCamp:
 - If you are using an Apple computer, see *Exporting Data from BaseCamp with an Apple Computer*, page 64.
 - If you are using a PC, see *Exporting Data from BaseCamp with a PC*, page 64.
- 2 Import your BaseCamp data to the Garmin Explore website (*Importing Data to Garmin Explore*, page 64).
- 3 Synchronize your Garmin Explore data with your zūmo device (*Synchronizing Garmin Explore Account Data*, page 20).

Exporting Data from BaseCamp with a PC

- 1 Select an option:
 - To export all BaseCamp data stored on your computer, select **My Collection**, and select **File > Export > Export 'My Collection'**.
 - To export one or more items or a list, select one or more items or a list, and select **File > Export > Export Selection**.
- 2 Enter a name, select a location for the exported file, select the file format, and select **Save**.

Exporting Data from BaseCamp with an Apple Computer

- 1 Select an option:
 - To export all BaseCamp data stored on your computer, select **My Collection**, and select **File > Export 'My Collection'**.
 - To export one or more items or a list, select one or more items or a list, and select **File > Export Selected User Data**.
- 2 Enter a name.
- 3 Select a location for the exported file.
- 4 Select the file format.
- 5 Select **Export**.

Importing Data to Garmin Explore

- 1 Go to explore.garmin.com and log in to your account.
- 2 Select the **Map** tab.
- 3 Select .
- 4 Follow the on-screen instructions.

The data syncs to the Tread app and your zūmo device automatically.

Viewing GPS Signal Status

Hold  for three seconds.

Purchasing Additional Maps

- 1 Go to your device product page at garmin.com.
- 2 Click the **Maps** tab.
- 3 Follow the on-screen instructions.

